

# Operating and assembly instructions



## Dosing system

### CPR Touch XL-2S

OI Part 1: for dosing device 2S, without control unit



Part 1, for OI of measuring and control unit:  
CPR Touch XL, No.: OI MR 001

## Table of contents

1	About these instructions / general .....	4
1.1	Scope of applicability .....	4
1.2	Target group .....	4
1.3	Symbols used .....	4
1.4	Warranty .....	6
1.5	Further information .....	6
2	Safety .....	7
2.1	Intended use .....	7
2.2	Safety notices .....	7
2.2.1	Handling of chemicals, risks to humans and the environment .....	7
2.2.2	Protective measures and rules of conduct .....	8
3	Product description - scope of delivery .....	9
3.1	Scope of delivery / accessories .....	9
3.2	Product description .....	9
3.2.1	Functioning of CPR TOUCH XL-2S, dosing device .....	9
3.2.2	Mounting plate with control unit, dosing device and measuring cell block .....	10
3.2.3	Disinfectant and pH regulator dosing .....	12
3.2.4	CPR Touch XL Control Unit (Standard) .....	12
3.3	Identification of device / nameplate .....	12
3.4	Technical data .....	13
3.5	Transport / storage .....	13
4	Assembly .....	14
4.1	Select the installation site .....	14
4.2	Assembly instructions / installation suggestion .....	14
4.3	Mechanical assembly .....	15
4.4	Hydraulic assembly .....	15
4.5	Electric assembly .....	17
5	Commissioning .....	19
5.1	Commissioning - remarks .....	19
5.2	Commissioning .....	19
5.2.1	Assembling hose pumps, roller support .....	19
5.2.2	Preparing pH control and disinfectant dosing for operation .....	20
6	Operation / service .....	22
6.1	General .....	22
6.2	Replenish consumables .....	22
7	Maintenance, care, faults .....	23
7.1	Device maintenance .....	23
7.1.1	Cleaning dirt filter .....	23
7.1.2	Changing the dosing hose of the dosing pump .....	23
7.2	Regular water check .....	23
7.3	Trouble-shooting .....	23
8	Decommissioning - Storage - Disposal .....	24
8.1	General .....	24
8.2	Decommissioning CPR TOUCH XL-2S dosing system .....	24
8.3	Disposal of used parts and operating materials .....	24

9 Documents.....	25
9.1 Declaration of conformity.....	25
9.2 Terminal diagrams .....	26
9.3 Commissioning protocol .....	27
9.4 Operation data sheet.....	28
9.5 Maintenance protocol .....	29
9.6 Spare parts list, wear parts list, consumables .....	30
10 Appendices.....	31

**Imprint:**

All rights reserved

© Copyright by WDT – Werner Dosiertechnik GmbH & Co KG

Edition: see footer

Reproduction of any kind and translation into other languages, even in excerpts, are only permitted with the express authorisation of the company WDT - Werner Dosiertechnik GmbH & Co. KG.

Subject to technical modifications

These operating instructions are an English translation of the original German version by the company WDT.

Responsible for the content:

Co. WDT - Werner Dosiertechnik GmbH & Co. KG

Hettlinger Str. 17

D-86637 Wertingen-Geratshofen

Phone:+49 (0) 82 72 / 9 86 97 – 0

Fax:+49 (0) 82 72 / 9 86 97 – 19

Email: [info@werner-dosiertechnik.de](mailto:info@werner-dosiertechnik.de)

## 1 About these instructions / general

### 1.1 Scope of applicability

These instructions describe the functioning, assembly, commissioning and operation of the CPR TOUCH XL-2S dosing system along with the corresponding accessories.

Read these operating instructions carefully prior to operating the device and keep them in close proximity to the device for immediate use!

**These Operating Instructions are valid in conjunction with the Operating Instructions Measuring and Control Unit CPR Touch XL No.: OI MR 001.**

### 1.2 Target group

Only our authorised partners and people who have been trained in the functioning of the device are permitted to work on the device, provided that they have read and understood these Operating Instructions.

Electrical connection work may only be carried out by appropriately trained specialists!

### 1.3 Symbols used

The following types of safety notices and general notices are used in this document:



#### **DANGER!**

"**DANGER**" denotes a safety notice which, if disregarded, **may lead to serious or life-threatening injuries!**



#### **CAUTION!**

"**CAUTION**" denotes a safety notice which, if disregarded, **may lead to minor or moderate physical injury!**



#### **ATTENTION!**

"**ATTENTION**" denotes a safety notice which, if disregarded, may lead to **material damage or malfunctions!**



#### **DANGER DUE TO ELECTRICAL VOLTAGE!**

"**DANGER DUE TO ELECTRICAL VOLTAGE**" denotes a safety notice which, if disregarded, may lead to **serious or life-threatening injuries, or to extensive material damage!**



## **CORROSIVE!**

"Corrosive" denotes a safety notice which, if disregarded when handling chemicals, may lead to **injuries or material damage**.



## **ESD SENSITIVE!**

"ESD SENSITIVE" denotes electronic components that may be damaged by electrostatic discharges. The generally accepted safety precautions for ESD-sensitive devices must be observed when handling the devices!



## **Tip!**

A "Tip" denotes information that may result in improvements in the operating process.



## **Mandatory sign**

Use face shield!



## **Mandatory sign**

Use protective gloves! In accordance with DIN EN 374



## **Mandatory sign**

Use protective apron!



## **Mandatory sign**

Use protective boots!

## 1.4 Warranty

All WDT devices and equipment are manufactured using modern production methods and are subject to comprehensive quality control. If reasons for a complaint should nevertheless arise, address the claim for compensation via your dealer to WDT, in accordance with the general terms and conditions of warranty (see below).

### General terms and conditions of warranty

The Co. WDT assumes a 2-year warranty, starting with the commissioning, up to 27 months after delivery; subject to correct installation and commissioning with a completed and signed commissioning protocol.

Exempt from this are wear parts such as gaskets, hoses, membranes, dosing screws, electrodes, roller supports and other parts that are subject to mechanical or chemical wear and tear. For these we assume a warranty of 1/2 year.

Our merchandise management programme requires an invoice for each delivery (including warranty services). When returning a defective component, upon review you will receive a corresponding credit, if applicable. We request a return within 14 days.

The costs for subsequent damages and for the processing of warranty claims are excluded.

There are no warranty claims for damages caused by frost, water and electrical overvoltage or by improper handling.



### **Tip!**

**For the safeguarding of any warranty claims, please send the completed commissioning protocol together with the defective component to WDT. Without the commissioning protocol, we reserve the right to assert a warranty regulation.**



### **ATTENTION!**

**It is not permitted to make any modifications to the device. If this specification is not observed, the warranty obligation and product liability will expire!**

## 1.5 Further information

Additional information concerning specific topics such as, for example, designing of the dosing flow or description of the operating parameters, may be obtained from your specialist dealer, or directly from:

WDT Werner Dosiertechnik GmbH & Co KG

Hettlinger Straße 17

86637 Wertingen - Geratshofen, Germany

Tel. +49 8272 98697-0

Fax. +49 8272 98697-19

<http://www.werner-dosiertechnik.de>

## 2 Safety

### 2.1 Intended use

The CPR TOUCH XL-2S dosing system may only be used for the purposes described in the product description! The locally applicable regulations concerning accident prevention, occupational safety and drinking water protection must also be observed!

### 2.2 Safety notices

Carefully read and comply with the operating instructions prior to assembly and use of the device!

Work on the device and changes in the settings may only be carried out by properly instructed persons!

#### Observe the warning notices on the device



#### 2.2.1 Handling of chemicals, risks to humans and the environment

In the event of an emergency when dealing with chemicals you can also contact the Emergency Poison Centre!

#### **Emergency number:**

#### **Munich Emergency Poison Centre (or any other Poison Centre)**

#### **Phone: +49 89 19240**

#### Excerpt from the Accident Prevention Regulations, GUV-V D 5

Installation rooms for chlorination systems and storage rooms

Section 3a. (1) Chlorination systems must be installed in lockable rooms and the chemicals intended for the chlorination must be stored in lockable rooms.

Re Section 3a Para. 1:

This requirement ensures that chlorination systems and chemicals shall be protected against weather effects and unauthorised access.

(2) Rooms in accordance with Para. 1 must not be intended for the permanent presence of persons.

Re Section 3a Para. 2:

..... A "permanent presence" is given when persons are present in the room for more than 2 hours per day. Repair and maintenance work on the chlorination system are exempt from this.

## 2.2.2 Protective measures and rules of conduct



### **CORROSIVE! SAFETY EQUIPMENT!**

The CPR TOUCH XL-2S dosing system doses both the disinfectant and the pH regulator from the dosing canister.

For this reason, the greatest possible care must be taken when working with chemicals and it is essential that personal safety equipment is worn:

Face shield, protective gloves, protective apron, boots.



The disinfectant and pH regulator must not be mixed with each other or with other chemicals or substances!

Store the chemicals so that they are not accessible to unauthorised persons.

When storing chemicals observe the information under *Section 3.5, Storage of chemicals.*

**More information can be found in the chemical manufacturer's safety data sheets!**



### **ESD SENSITIVE!**

The electronic components in the device controls are sensitive to electrostatic discharge. The generally accepted safety precautions for ESD-sensitive devices must be observed when handling the components.

- Disconnect the device from the voltage supply
- Discharge of personal static charge



## **3 Product description - scope of delivery**

### **3.1 Scope of delivery / accessories**

The scope of delivery includes the "CPR TOUCH XL-2S" dosing system, which consists of the following components:

- Dosing device for disinfectant
- Dosing device for pH regulator
- Control with 7" colour display (see OI Part 2)
- Fine filter
- Suction set

The following options are available for the dosing system

- a) Remote display

### **3.2 Product description**

The CPR Touch XL-2S dosing system is designed for carrying out measuring and control tasks when treating swimming pool water for public and private swimming pools.

#### **3.2.1 Functioning of CPR TOUCH XL-2S, dosing device**

The CPR TOUCH XL-2S dosing system doses the disinfectant and the pH regulator required for neutralisation into the piping of the swimming pool water circuit.

#### Functions of the CPR TOUCH XL-2S

- Measuring free chlorine with open measuring cell, potentiostatic. pH value, redox potential and temperature
- Controlling chlorine dosage using the measured value for free chlorine or redox potential.
- Disinfectant dosing using hose dosing pump from the delivery canister
- pH regulator dosing using hose dosing pump from the delivery canister

Operating principle of the CPR TOUCH XL-2S dosing system.

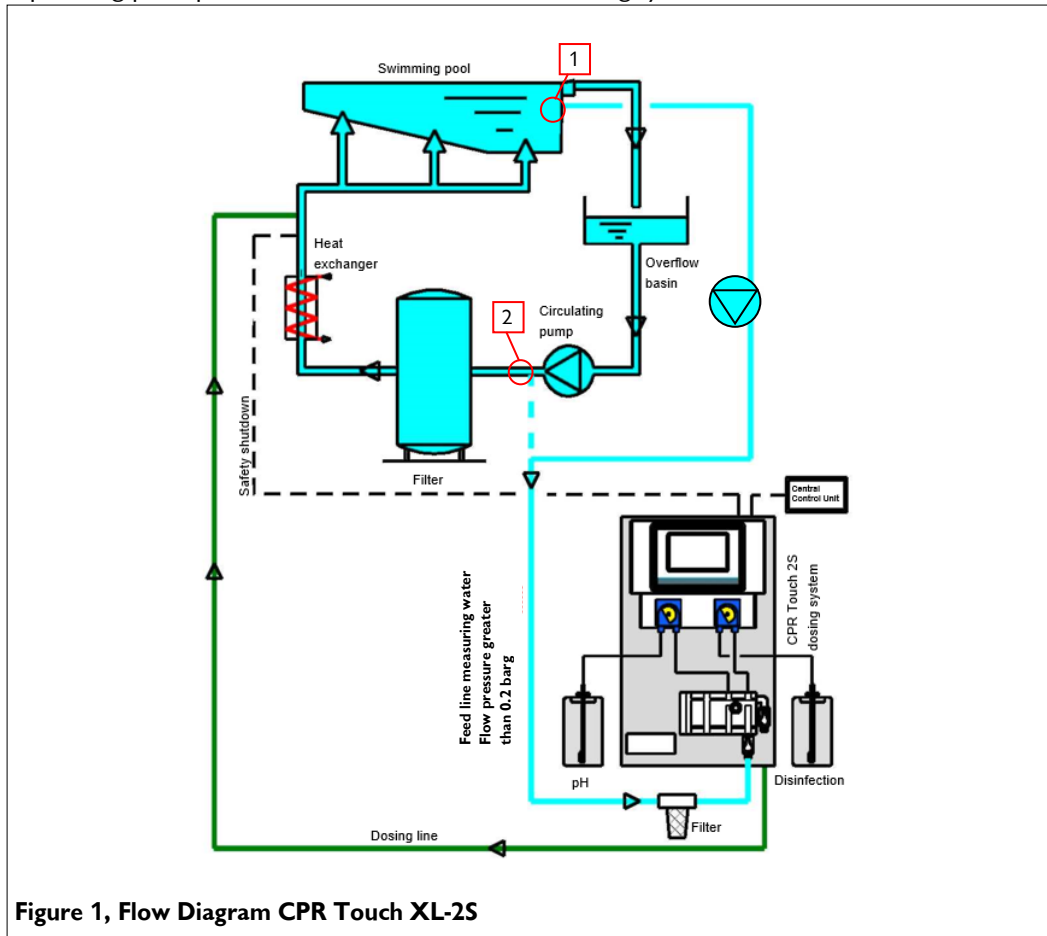

Figure 1, Flow Diagram CPR Touch XL-2S

### 3.2.2 Mounting plate with control unit, dosing device and measuring cell block

The dosing device is delivered as a ready-assembled unit on a mounting plate. This ensures that the device is securely installed.

For transportation purposes, both electrodes along with the glass shaft have been removed from the measuring cell and delivered in a packaging box. In order to prevent the dosing hoses from becoming deformed during prolonged storage, the roller supports for the hose pumps have been removed from the motor shaft and enclosed.

The device is fitted with a touch-sensitive display. By touching a symbol or a numeric value, this will be activated for parametrisation. The adjustment menus come with additional text-based instructions.

In order to eliminate the risk of confusing both chemicals as far as possible, the dosing technology is colour-coded throughout. The colour-coding runs from the suction lance over the associated dosing pump to the dosing valve. The parts used for pH value control are located to the left and coded red. The components used for disinfection are located on the right and coded yellow.



#### **Tip!**

**The chemical canisters with collecting basins must be provided by the customer. Observe the locally applicable regulations when handling chemicals.**

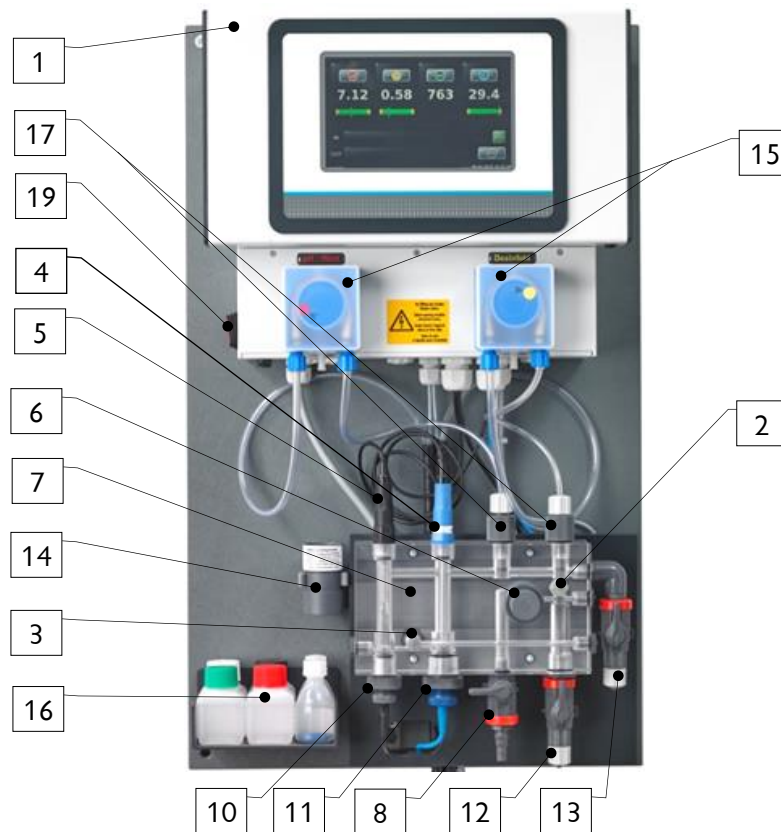

**Figure 3, CPR Touch XL-2S**

1. Control CPR Touch XL
2. Flow monitoring
3. Temperature sensor
4. Combination reference-return electrode (blue)
5. pH electrode (black)
6. Flow control valve
7. PMMA measuring cell block
8. Test water tap
9. Prefilter (optional, for wall-mounting, not depicted)
10. Redox electrode
11. Chlorine electrode
12. Measuring water intake
13. Measuring water return flow
14. Redox test cylinder
15. 2 dosing pumps Sa
16. Buffer solution and electrode cleaner
17. Dosing valves
18. Suction set (not visible in image)
19. Main switch

### 3.2.3 Disinfectant and pH regulator dosing

The pH dosing in the CPR TOUCH XL-2S operates the pH control. The pH dosing is controlled automatically by the control unit.

The pH- and disinfectant dosing is performed using hose pumps (15). Hose pumps are able to convey even the smallest dosing quantities reliably and



Figure 4, pH- and disinfection dosing pump

evenly, even when air or gas bubbles are trapped in the suction line. Rotating rollers press the dosing hose against the casing wall, which pushes the liquid in the hose out from the rollers while simultaneously feeding behind it. It is exceptionally reliable and easy to operate. The hose pump sucks the chemicals through the suction set (18) from the chemical canisters. The fill level in the canisters is determined for the empty signal using level switches.

Use acid based on 37-50% sulphuric acid as a pH reducer. Concentrated **hydrochloric acid** destroys the hose pump – **dilute to below 10%!** In solutions consisting of **sodium bisulphate** "dry acid" , **do not use concentrations above 20%** (equivalent approx. to 10% sulphuric acid).

Use sodium hypochlorite as a disinfectant.

### 3.2.4 CPR Touch XL Control Unit (Standard)

Control Unit (Version CPR TOUCH XL-2S)

See OI "CPR-Touch XL measuring and control unit", No.: OI MR 001.

### 3.3 Identification of device / nameplate

Enter the data from the nameplate of your device here.

<b>Typ: CPR-Touch XL 2S</b>
<b>Art.:</b> <input type="text"/> <b>Serien Nr.:</b> <input type="text"/>
<b>230V/AC 1Ph ~50Hz I max. 2A</b>
<b>Dosierleistung CI max. 2500ml/h</b>
<b>pH max. 1250ml/h</b>
<b>CE</b> <b>Herstellung</b> <input type="text"/>
<b>WDT - Werner Dosiertechnik GmbH &amp; Co. KG</b>
<b>Hettlinger Str. 17 D-86637-Wertingen</b>

Field 1: Article no.:

Field 2: Serial no.:

Field 3: Enter date of manufacturing

## 3.4 Technical data

	CPR TOUCH XL-2S
<b>Dimensions and weights:</b>	
Device dimensions	W 48cm, D 17cm, H 67cm
Device space requirement (base)	W 100cm, D 80cm, H 200cm
Space requirement incl. operation and maintenance	W 100cm, D 120cm, H 210cm
Empty weight / operating weight	approx. 12kg / 12.3kg
<b>Connection data</b>	
Electric connection data	230VAC/50Hz ± 10%, 8W, I max. 2A, Schuko plug
Protection class	IP 54
Hydraulic connection data	Intake 6x1mm Outlet 6x1mm
Required duct connection	—
Operating pressure	Max. 2.0 barg
Required inlet pressure	Min. 0.2 barg
Max. permissible counter-pressure	0 - 1.0 barg
Water supply	From swimming pool using measuring water pump: Flow pressure min. 0.2 barg  <u>In exceptional cases:</u> Between circulating pump and swimming pool filter, before chemical dosing Flow pressure min. 0.2 barg
<b>Operating data:</b>	
Dosing flow disinfection	0.2l/h, 0.7l/h or 2.5l/h, depending on design
Dosing flow pH regulator	0.1l/h, 0.35l/h or 1.25l/h depending on design
Water flow	100l/h
Medium temperature	5°C to 35°C
Ambient temperature	5°C to 35°C
Humidity engineering room	Max: 70%
Room ventilation (in and out)	
Material	Other functioning parts: PVC or PE Gaskets: EPDM, viton

## 3.5 Transport / storage

Please check the devices immediately upon receipt for potential transport damage.



### **ATTENTION!**

**The device may be damaged by frost or high temperatures. Avoid exposure to frost during transport and storage!**

**Do not store systems and devices next to objects with strong heat emission or in direct sunlight. The device may only be transported and stored in its original packaging. Please ensure careful handling.**

Storage of chemicals



### **DANGER!**

**Please comply with the chemicals manufacturer's safety data sheets!**

In addition, please observe the provision regarding the storage of chemicals TRGS 515.

## 4 Assembly

### 4.1 Select the installation site

The following should be observed for installation site:

1. A freely accessible assembly location should be selected to facilitate operations and subsequent maintenance tasks.
2. Observe the temperature specifications for the surrounding air and medium in accordance with *Section 3.4 Technical Data*. No flammable vapours, dust or gases may be present in the immediate vicinity of the device.
3. The device must not be exposed to the elements. It may not be installed outdoors. The device must be protected from frost and direct sunlight.
4. An electricity grid connection must be available. If online functions are used, an Internet connection will also be required.
5. The service room must not be used as a recreation space. (max. 2 hours per day), consult the locally applicable accident prevention regulations (Germany BGR-GUV-R 108).
6. It must comply with the accident prevention regulations and should not be accessible to unauthorised persons. A separate storage space must be available for the chemicals.
7. Collecting basins must be available for use with the chemical canisters.
8. It must be possible to vent and aerate technical areas so that hazardous substances do not occur in health-endangering concentrations (from accident prevention regulations BGR-GUV-R 108).

### 4.2 Assembly instructions / installation suggestion

- Unpack the device
- Attach warning and notice signs in accordance with the locally applicable accident prevention regulations (Germany: BGR-GUV-R 108) at the designated positions.

#### Suggested installation

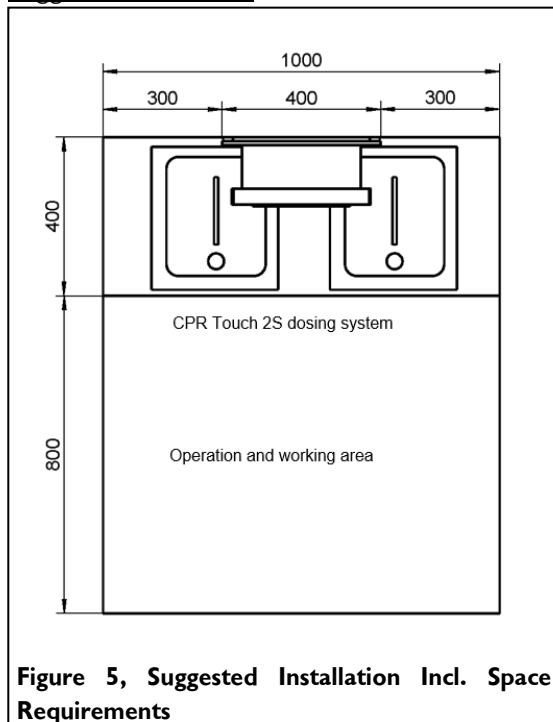

## 4.3 Mechanical assembly

The dosing system is delivered pre-assembled on the mounting plate. Unpack the device and mount on the wall in the utility room using 4 screws. The selected mounting height must ensure that the device is located at eye level. Measure the four drill holes on the mounting plate and mark their location on the wall. Use dowels and screws appropriate for the type of masonry.

Place the dosing canister and the corresponding collecting container under the device.



**Pay attention to the positioning of the container,**  
**left → pH Value control chemical (red) and**  
**right → Disinfectant chemical (yellow).**

**Ensure that there is sufficient clearance for operating and servicing the device!**

## 4.4 Hydraulic assembly

Integration into water circuit:

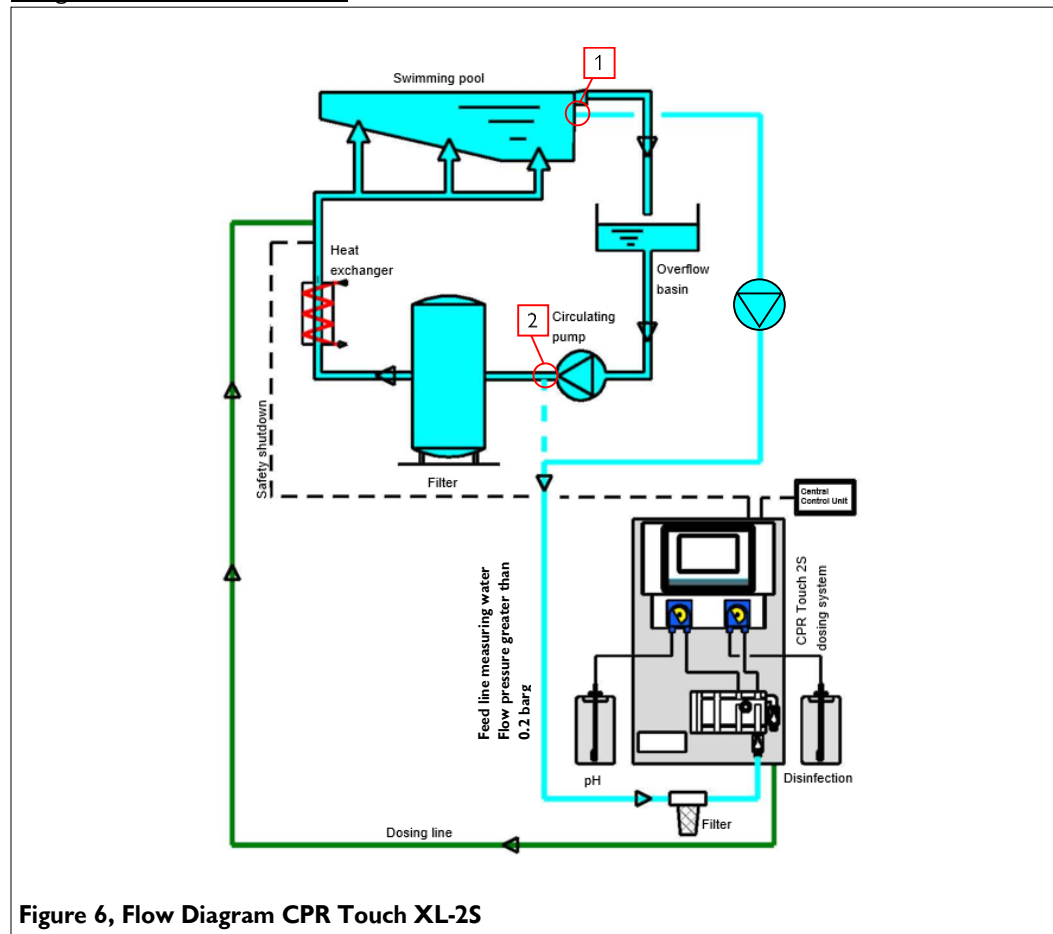

Figure 6, Flow Diagram CPR Touch XL-2S



### **ATTENTION!**

**Before beginning any connection works, ensure that all of the ball valves on the measuring cell block are closed.**

The measuring water supply for the CPR TOUCH XL-2S should be separated from the swimming pool filter circuit so that it does not affect the swimming pool circuit.

## Flow

Only "good" basin flow can achieve a satisfactory control of the auxiliary hygiene parameters free chlorine, pH value and redox voltage. The dosed chemicals must reach all areas of the basin within a short time. Even under stress, the concentrations measured in different areas of the basin must be approximately the same.

## Measuring water withdrawal

Choosing the right measuring water withdrawal point is crucial for the effectiveness of the measuring and control technology. The measuring water should, where possible, be identical to the basin water; it should be possible to detect changes to the water quality in the basin as quickly as possible by metrological means. Only this way will it be possible to compensate for changes in the basin water quality quickly by additional chemical dosing. The optimal withdrawal point can be located by measuring the chlorine concentration at different points (e.g. behind the circulating pumps, mixed water, etc.) and comparing with the values from the basin water in various operational conditions.



## **ATTENTION!**

**No chemicals must be dosed before the measuring water withdrawal point. This would distort the measurement results.**

If the basin water is conducted through an overflow gutter and an equalisation basin (splash water basin), also used for the freshwater feed-in, only sampling the measuring water directly from the swimming pool basin will lead to satisfactory measuring and control results.

In new systems, measuring water must be withdrawn directly from the basin, in accordance with DIN 19643!

If there are any existing connections, ensure that they are not blocked. The pipes should be kept as short as possible.

Ensure that the connection sleeves for the water withdrawal and the dosing point are completely open.

There are 2 options for the water withdrawal point:

Option 1: (see Figure 6) Swimming pool water directly from the basin

- Water withdrawal at least 80cm under the water top level. The flow pressure at the measuring water intake must be at least 0.2 barg. Install CPR TOUCH XL-2S a short distance under level of the withdrawal point. The height difference between the dosing device and the water surface should be at least 2m.

Option 2: (see Figure 6) Swimming pool water before pool filter

- Water withdrawal between circulating pump and filter, before chemical dosing with 1/2" sleeve. The flow pressure at the intake must be at least 0.2 barg.

Connect the measuring water intake (Pos 12) of the CPR TOUCH XL-2S to the water withdrawal point.

Measuring water recirculation (injection point)

Since the chemicals are mixed in with the measuring water, the injection point for the measuring water recirculation must be installed in the direction of flow behind the heat exchanger in order to prevent corrosion! Install the dosing line from the dosing device to the injection point.



Connect the measuring water recirculation (Pos 13) of the CPR TOUCH XL-2S to the water withdrawal point.

### Design of measuring water withdrawal and recirculation



The immersion tube must extend into the middle of the pipe.

### Prefilter (optional)

It is not possible for the pool operator to see a contaminated prefilter from under the design cover. For this reason, the prefilter must be installed in the measuring water feed line, at an easily accessible location. Depending on the local conditions, the prefilter can be installed directly at the device or at any other good installation site along the pipe. This has the advantage of making it possible to select a more convenient access point for the pool operator.

## 4.5 Electric assembly



### **DANGER DUE TO ELECTRICAL VOLTAGE!**

**Electrical installation must only be carried out by qualified personnel!  
Before any electrical works are carried out, the power supply must be switched off and secured against being reactivated!**

### Electrical connection

Open and close the casing



**Figure 8, Control Unit Casing**

Depending on the type of device, the display lid can be swivelled to the left or right for installation and maintenance work. The locking axle must be removed for swivelling. The locking axle is identified by the plastic slotted screws on both sides. The other side is equipped with two expanding rivets as pivot bearings.

The device must be supplied with continuous voltage. I.e., the voltage supply must not be locked with the filter system. **A digital input is available for interlocking the dosing with the swimming pool's filter system.**

For electrical installation, see also terminal diagrams in terminal casing of the control unit or in the OI for CPR Touch XL measuring and control unit, in *Section 9.2*.

Signals to and from outside, see terminal diagrams



## **ATTENTION!**

**External control of the inputs must be carried out in isolation.  
The maximum contact current capacity of the relay contacts must be observed.**

The power supply for the dosing device must always be ensured.

The external control inputs and outputs (shutdown in the event of fault, disinfectant dosing during backwashing etc.) must be clamped to the clamping connectors of the baseplate in the control unit casing. Please do not use any fixed wire conductors.

Insert lines

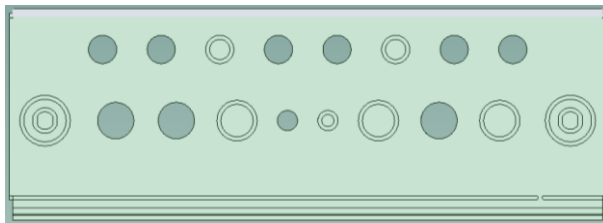

The casing comes with several factory-made free screw connections. Several push-outs for metric cable screw connections are available for additional insertions.

The two external screw connections with M25 are intended for the

insertion of a preassembled interface cable with RJ45 plug.



## **ATTENTION!**

**Please pay attention to the spatial separation between energy and signal lines when inserting additional lines. The crossing of energy and signal lines must be avoided!**

Upon completion of the work, the casing must be properly closed again!

The device is equipped with a temperature control. This temperature control can be used to regulate the basin water temperature. If the basin is heated by means of a flow-through heat exchanger, it must be ensured that the associated heating circuit can only be activated when the filter system is in operation and that the temperature sensor is installed using a thermowell in the flow direction after the heat exchanger.

Please remember that the regulation of the basin temperature can only be guaranteed if the filter operation times are set to an appropriate duration.

If the pool is being operated with an overflow gutter and a splash water tank, into which freshwater is also allowed to enter, marked differences in the water quality must be expected. In order to ensure perfect control quality in this case, it is recommended that the measuring water is withdrawn directly from the basin, using a separate measuring water pump.

## 5 Commissioning

### 5.1 Commissioning - remarks



#### **ATTENTION!**

**This chapter must also be observed every time recommissioning occurs after an operating pause.**

The work described here may only be carried out by trained specialist personnel from a specialist company. Prior to commissioning, the installed systems must be checked for proper installation and leaks.

Please use the commissioning protocol from *Section 9.3.* for commissioning. The device is delivered with defined factory settings. You can find the setting values in the operation data sheet under *Section 9.4.*

### 5.2 Commissioning

Before starting the commissioning process, ensure that the ball valves are connected to the measuring cell block (7) of the control unit.

#### 5.2.1 Assembling hose pumps, roller support

The description applies to both hose pumps of the CPR TOUCH XL-2S

1. Remove the clipped-in, transparent pump cover and the blue retaining washer. Pull the hose bracket forwards out of the guide in the casing.

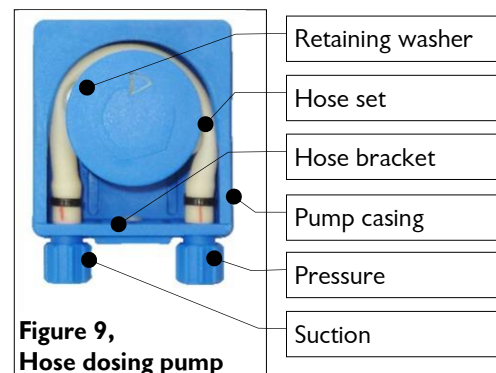

**Figure 9,  
Hose dosing pump**

2. Push the blue roller support provided with the delivery onto the axle.



**Figure 10,  
Insert roller support**

3. Insert the hose bracket into the guides of the casing until it firmly snaps into place.



Figure 11,  
Insert the hose bracket

4. Turn the roller support counter-clockwise while carefully pushing the hose inside the housing until the entire hose is contained in the housing.



Figure 12,  
Turn roller support

Now position the retaining washer (with red point for pH dosing, with yellow dot for disinfectant dosing). Next, position the transparent pump cover. This completes the assembly of the roller support.

For dismantling the roller support and the hose bracket, please proceed in the reverse sequence.

## 5.2.2 Preparing pH control and disinfectant dosing for operation



### **PROTECTIVE CLOTHING!**

**Personal safety equipment must be put on before starting work with chemicals: Protective gloves, aprons, face shield, boots.**

**The specifications for each chemical given in the safety data sheets must be observed.**

Connect dosing canister



### **CAUTION!**

**The chemicals and the suction lances must not be confused! Pay attention to the colour coding!**

**Components marked red must be used for pH dosing.**

**Components marked yellow must be used for disinfectant dosing.**

**Do not use any hydrochloric acid as this diffuses through the dosing hose and corrodes the dosing motor.**

Toxic fumes may occur when handling chemicals. Do not inhale any fumes.

1. Unscrew the screw cap with the suction lance from the empty dosing canister, put the suction lance in the collecting basin, and close the empty canister immediately using the original screw cap.
2. Lift the empty canister out of the collecting container.
3. Put the full dosing canister into the collecting container. Pay attention to the colour coding!
4. Unscrew the screw cap from the full dosing canister, insert the suction lance into the canister immediately and close it securely.
5. Store the original screw cap of the dosing canister until the next time the canister is replaced.

Plug the safety plug in a corresponding socket and turn on the device at the main switch.



## **Tip!**

**The commissioning of the dosing device is now complete. For further commissioning, and the operation and setting of the control unit, continue reading the Operating Instructions Part 2, "Measuring and Control unit CPR-Touch XL" No. "BA MR 001" under Section 5 and Section 6.**

## 6 Operation / service

The nationally applicable accident prevention regulations in Germany: Operation of swimming pools BGR/GUV-R 108 must be observed.

### 6.1 General

For operating and setting the dosing device, continue reading in the Operating Instructions Part 2, "Measuring and Control Unit *CPR Touch XL*" No. OI MR 001 under Section 6.

### 6.2 Replenish consumables



#### **CAUTION!**

**The safety data sheets for each chemical must be observed.**

- Refilling pH control or disinfectant  
Replacing pH control or disinfectant canister see Section 5.2.2, "Connecting Dosing Canister".  
The specifications for each chemical given in the safety data sheets must be observed!

## 7 Maintenance, care, faults

### 7.1 Device maintenance

We recommend that you assign a specialist firm to carry out regular maintenance.



#### **Tip!**

The maintenance work required for trouble-free operation is listed in the maintenance protocol in **Section 9.5**.

For opening the control unit casing see **Section 4.5**.



#### **DANGER FROM ELECTRICAL VOLTAGE!**

Before any electrical works are carried out, the device must be disconnected from the power supply and secured against being reactivated! Otherwise there is a risk of electric shock.

#### 7.1.1 Cleaning dirt filter

It is important that the prefilter is kept clean so that the device can function properly. If the prefilter is contaminated, the pressure will drop.

When working on lines that carry water, always close the inlet and outlet valves!

For cleaning, unscrew the filter hood on the filter. Pull the filter element out. Clean the filter hood and the filter element under running water. Reassemble the filter in the reverse order.

#### 7.1.2 Changing the dosing hose of the dosing pump

Additional procedure see *Section 5.2.1, Assembling hose pumps*, roller support

### 7.2 Regular water check

See: OI "CPR-Touch XL Measuring and Control Unit", No.: OI MR 001, in *Section 7.2*.

### 7.3 Trouble-shooting



#### **Tip!**

Faults are indicated in the display in the IN list by the appropriate symbol.



See: OI "CPR-Touch XL Measuring and Control Unit", No.: OI MR 001, in **Section 7.3**.

## 8 Decommissioning - Storage - Disposal

### 8.1 General

In the event of decommissioning or risk of frost, the devices must be emptied completely and protected against frost!

### 8.2 Decommissioning CPR TOUCH XL-2S dosing system

1. Remove the suction lances from the dosing canisters and place them in a bucket filled with clean water. Close the dosing canister.
2. Allow the system to run for a further 10 mins. approx. for rinsing and cleaning. Use the "Output test" function .
3. Stop dosing using the  button.
4. Remove the roller support from the hose dosing pumps in order to release the dosing hose.
5. If there is a risk of frost, drain all of the water-conveying parts, and in particular the pumps.
6. If condensation moisture can be expected in the storage space, the device must be supplied with continuous voltage. Otherwise, deactivate the dosing device at the main switch.



### **ATTENTION!**

**When recommissioning, it is essential that the instructions in the chapter on "Commissioning" are observed and the points contained in the commissioning protocol implemented.**

### 8.3 Disposal of used parts and operating materials

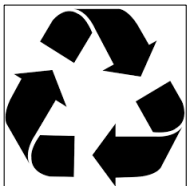

Clean any dismantled, contaminated parts thoroughly first; recycle them or dispose of them in accordance with the regulations applicable at the operating location.



For the operating materials, observe the corresponding packaging notices. If in doubt, information may be obtained from the institution responsible for disposal at your location.

If this is not possible, dispose of the components/materials as hazardous waste.



## 9 Documents

### 9.1 Declaration of conformity

<p>WDT Werner Dosiertechnik GmbH &amp; Co. KG Hettlinger Straße 17   D-86637 Wertingen Tel. 0049 8272 98697-0   Fax 0049 8272 98697-19 info@werner-dosiertechnik.de   www.werner-dosiertechnik.de</p>			
<p><b>EG Konformitätserklärung</b> <b>EC declaration of conformity</b> <b>UE Déclaration de conformité</b></p>			
Hersteller: Manufacturer: Fabricant:	WDT – Werner Dosiertechnik GmbH & Co.KG Hettlinger Str. 17 86637 Wertingen		
Produkt: Product: Produit:	Mess- Regel- und Dosiergerät Typ CPR Touch XL 2S		
Artikel-Nr.: Article-no.: Numéro d` article:	24648		
<p>Wir erklären, dass das genannte Produkt in Ihrer Bauart mit den Bestimmungen der EG-Richtlinien entspricht. We confirm that the a.m. product corresponds to the regulations of the EC-instructions with regard to its construction. Nous déclarons que les produits mentionnés correspondent aux normes UE.</p>			
<p>Die zutreffenden Punkte erfüllen die Anforderungen der: The respective points are meeting the requirements of the: Les points suivants répondent aux normes :</p>			
Niederspannungsrichtlinie Low voltage directive Directive de basse tension	EN 61010-1 (2011-07), EN ISO 12100:2011		
Elektromagnetische Verträglichkeit Electromagnetic compatibility Compatibilité électromagnétique	EN 55014-1 (2012-05) EN 55014-2 (2009-06)		
Angewendete harmonisierte Normen Used harmonized standards Normes harmonisées appliquées	DIN 19643 (2012-12)		
Datum/date: _____	04.07.2017	Unterschrift/signature:	 Jochen Rieger – Director
			 <p>Qualitätsengagement Wir sind zertifiziert Registrierte Niederlage Überwachung nach ISO 9001:2008</p>

---

## 9.2 Terminal diagrams

---

The terminal diagrams for the standard version of the device may be found in the Operating Instructions Part 2 "CPR-Touch XL Measuring and Control Unit", No.: OI MR 001, in Section 9.2.

The circuit diagrams may also be found in the terminal box of the device.

---

## 9.3 Commissioning protocol

---

The commissioning protocol is located in the accompanying documentation.

---

## 9.4 Operation data sheet

---

See Operating Instructions Part 2, "CPR-Touch XL Measuring and Control Unit", No.: OI MR 001. in Section 9.4.

---

## 9.5 Maintenance protocol

---

The maintenance protocol is located in the accompanying documentation.

## 9.6 Spare parts list, wear parts list, consumables

The spare parts listed below can be obtained from your specialist dealer. Please include the exact product designation and the device serial number with all orders.

### Spare part list

	<u>Designation</u>	<u>Item no.</u>
Dosing	Cover for pump casing Sa, transparent	14259
	Retaining washer blue for roller support Sa	13633
	Dosing valve 3/8" - 4 x 1 - Si 9 1.5/14	24718
	Suction set 16/500 NF 2 m complete - yellow	12472
	Suction set 16/500 NF 2 m complete - red	12473
Accessories	Protective basin – chemical canister 30 litres	24300

### Wear parts list

Wear parts are excluded from the 2-year warranty!

	<u>Designation</u>	<u>Item no.</u>
Dosing	Gear motor Sa 24 VDC 80 U/min	18769
	Pump casing Sa blue	14140
	Roller support Sa blue	13039
	Hose bracket Sa 3.2 x 1.6 hose break complete - green	16344
	Hose bracket Sa 1.6 x 1.6 hose break complete - black	16345
	Hose bracket Sa 0.8 x 1.6 hose break complete - blue	16346
	Union nut Sa – hose connection 4 x 1 mm	16379
	Clamp ring Sa PVDF 4 x 1 mm	16867
	Hose set Sa 3.2 x 1.6 - Ph (2 pcs) - green	13413
	Hose set Sa 1.6 x 1.6 - Ph (2 pcs) - black	13412
	Hose set Sa 1.6 x 1.6 - Ph (2 pcs) - blue	13482
	Valve rubber 9x1.5x14mm- 2 pcs in bag	18860

### Consumables

Please comply with the chemicals manufacturer's safety data sheets!







# Commissioning Protocol IP 43 CPR Touch XL-2S



This protocol must be completed by the commissioning technician! Without a completed and signed commissioning protocol, all warranty claims become void!

Object: \_\_\_\_\_ Date: \_\_\_\_.

City, street, house number: \_\_\_\_\_

Device type: \_\_\_\_\_ Year of manufacture: \_\_\_\_\_ Serial number: \_\_\_\_\_

	Activity	Completed	Comment
<b>1</b>	<b><u>Measuring Cell Block (see OI Part 2 Measuring and Control Unit No.: MR 001)</u></b>		
1.1	Install the roller support for the hose pumps	<input type="checkbox"/>	
1.2	Insert the cleaning beads	<input type="checkbox"/>	
1.3	Install electrodes	<input type="checkbox"/>	
1.4	Set control parameters	<input type="checkbox"/>	
1.5	Open ball valve at measuring cell intake, set measuring cell flow	<input type="checkbox"/>	
<b>2</b>	<b><u>Dosing Technology Disinfection (Chlorine)</u></b>		
2.1	Check empty switch on suction lance: Indicator in display	<input type="checkbox"/>	
2.2	Connect suction lance to dosing canister (yellow)	<input type="checkbox"/>	
2.3	Check dosing pump: Program output test chlorine (disinfection)	<input type="checkbox"/>	
<b>3</b>	<b><u>Dosing Technology pH Value (Acid)</u></b>		
3.1	Check empty switch on suction lance: Indicator in display	<input type="checkbox"/>	
3.2	Connect suction lance to dosing canister (red)	<input type="checkbox"/>	
3.3	Check dosing pump: Program output test pH	<input type="checkbox"/>	
<b>4</b>	<b><u>Other</u></b>		
4.1	Clean dosing device with a damp cloth	<input type="checkbox"/>	
4.2	Discuss and hand over operating instructions	<input type="checkbox"/>	

Additional remarks:

---



---



---



---



---



---

Commissioning and instruction carried out by: \_\_\_\_\_

Instructed persons: \_\_\_\_\_

Signature of commissioner: \_\_\_\_\_

Operator's counter-signature: \_\_\_\_\_



# Maintenance Protocol WP 49

## CPR-Touch XL-2S



This protocol must be completed by the maintenance technician! Without a completed and signed maintenance protocol, we reserve the right to assert a warranty regulation.

Object: \_\_\_\_\_ Maintenance year: 20\_\_

City, street, house number: \_\_\_\_\_

Device type: \_\_\_\_\_ Year of manufacture: \_\_\_\_\_ Serial number: \_\_\_\_\_

	Activity	Maintenance interval in months													Comment / additional work	
			Month 1	Month 2	Month 3	Month 4	Month 5	Month 6	Month 7	Month 8	Month 9	Month 10	Month 11	Month 12		
<b>1</b>	<b><u>Dosing Device Disinfection (Chlorine)</u></b>															
1.1	Check hose pump for moisture and corrosion	1	<input type="checkbox"/>	<input type="checkbox"/>	<input type="checkbox"/>	<input type="checkbox"/>	<input type="checkbox"/>	<input type="checkbox"/>	<input type="checkbox"/>	<input type="checkbox"/>	<input type="checkbox"/>	<input type="checkbox"/>	<input type="checkbox"/>	<input type="checkbox"/>	<input type="checkbox"/>	
1.2	Check empty switch functioning	6						<input type="checkbox"/>							<input type="checkbox"/>	
1.3	Replace dosing hose	12													<input type="checkbox"/>	
<b>2</b>	<b><u>Dosing Device pH Value (Acid)</u></b>															
2.1	Check hose pump for moisture and corrosion	1	<input type="checkbox"/>	<input type="checkbox"/>	<input type="checkbox"/>	<input type="checkbox"/>	<input type="checkbox"/>	<input type="checkbox"/>	<input type="checkbox"/>	<input type="checkbox"/>	<input type="checkbox"/>	<input type="checkbox"/>	<input type="checkbox"/>	<input type="checkbox"/>	<input type="checkbox"/>	
2.2	Check empty switch functioning	6						<input type="checkbox"/>							<input type="checkbox"/>	
2.3	Replace dosing hose	12													<input type="checkbox"/>	
<b>3</b>	<b><u>Control</u></b>	12													<input type="checkbox"/>	
3.1	Check all inputs	12													<input type="checkbox"/>	
3.2	Check all outputs	12													<input type="checkbox"/>	
3.3	Check and correct parameter settings	12													<input type="checkbox"/>	
<b>4</b>	<b><u>Measuring Cell Block</u></b>															
4.1	Check and clean the prefilter	1	<input type="checkbox"/>	<input type="checkbox"/>	<input type="checkbox"/>	<input type="checkbox"/>	<input type="checkbox"/>	<input type="checkbox"/>	<input type="checkbox"/>	<input type="checkbox"/>	<input type="checkbox"/>	<input type="checkbox"/>	<input type="checkbox"/>	<input type="checkbox"/>	<input type="checkbox"/>	
4.2	Replace chlorine electrode, sealing set	12													<input type="checkbox"/>	
4.3	Replace redox electrode, sealing set	12													<input type="checkbox"/>	
4.4	Replace flow controller, maintenance set	12													<input type="checkbox"/>	

Additional remarks:

---



---



---



---

Maintenance performed and device functioning checked: \_\_\_\_\_ Date: \_\_\_\_\_  
Signature

Operator's counter-signature: \_\_\_\_\_



## Operating and assembly instructions



### Measuring and control unit CPR

## Touch XL with measuring cell block

### OI Part 2: for control unit

Measuring technology for pH values, free chlorine, redox voltage and temperature



Part 2, regarding the OI for the dosing devices:

- Granudos 10-CPR Touch XL, No.: BA SW 002
- Granudos 45/100-CPR Touch XL, No.: BA SW 003
- CPR Touch XL-2S, No.: BA SW 004

## Table of contents

1	About this manual / general.....	4
1.1	Scope of applicability .....	4
1.2	Target group .....	4
1.3	Symbols used.....	4
1.4	Warranty .....	6
1.5	Further information.....	6
1.6	Information regarding support queries .....	6
2	Safety .....	8
2.1	Intended use.....	8
2.2	Safety notices .....	8
2.2.1	Handling of chemicals, risks to humans and the environment.....	8
2.2.2	Protective measures and rules of conduct.....	9
2.2.3	Activation of remote access .....	9
3	Product description - scope of delivery .....	11
3.1	Scope of delivery / accessories.....	11
3.2	Product description .....	11
3.2.1	Device overview.....	12
3.2.2	Control CPR Touch XL (standard).....	14
3.2.3	The measuring cell block.....	14
3.3	Identification of the device / nameplate.....	14
3.4	Technical data.....	15
3.5	Transport / storage.....	16
4	Assembly.....	17
4.1	Select the installation site.....	17
4.2	Assembly instructions / installation suggestion .....	17
4.3	Mechanical assembly.....	17
4.4	Hydraulic assembly.....	17
4.5	Electric assembly .....	17
5	Commissioning.....	18
5.1	Commissioning, - comments.....	18
5.2	Commissioning tasks .....	18
5.2.1	Insert the cleaning beads .....	18
5.2.2	Insert pH and combination electrodes with glass shafts .....	19
5.2.3	Set the measuring cell flow rate .....	19
5.2.4	The control parameters .....	19
6	Operation / service.....	20
6.1	General .....	20
6.2	The control unit CPR Touch XL .....	20
6.2.1	Operation display - Display auto mode.....	20
6.2.2	Automatic operation .....	24
6.2.3	QuickInfo .....	24
6.2.4	Start - Dosing delay .....	24
6.2.5	Alarm.....	24
6.2.6	Automatic - Startup.....	25
6.2.7	Automatic – Redox control (emergency programme) .....	25
6.2.8	Manual dosing (emergency programme).....	25
6.2.9	Main menu → Settings (overview) .....	26
6.2.10	Main menu → Service .....	36
6.2.11	Main menu Login.....	37
6.2.12	Main menu → Log (event and data logging).....	37
6.2.13	Main menu → Calibration .....	39

6.3	Refill consumables .....	42
7	Maintenance, care, faults .....	43
7.1	Device maintenance.....	43
7.1.1	Check and clean the prefilter .....	43
7.1.2	DPD1 Measuring – free chlorine calibration.....	43
7.1.3	pH measurement – calibrate pH electrode .....	44
7.1.4	Combination reference-return electrode.....	44
7.1.5	Chlorine electrode - exchange the gasket set .....	44
7.1.6	Redox electrode - exchange the gasket set .....	45
7.1.7	Flow regulator - exchange the maintenance set.....	45
7.1.8	Open and close the casing .....	45
7.2	Regular water check.....	46
7.3	Disruption removal .....	47
8	Decommissioning - storage - disposal .....	50
8.1	General .....	50
8.2	Decommissioning .....	50
8.3	Disposal of used parts and operating materials.....	50
9	Documents.....	51
9.1	Declaration of conformity .....	51
9.2	Terminal diagrams.....	51
9.2.1	Terminal diagram power supply unit for device 2S.....	52
9.2.2	Terminal diagram I/O Board for device 2S .....	53
9.2.3	Terminal diagram I/O Board for external dosing unit .....	54
9.2.4	The measuring amplifier .....	55
9.2.5	Terminal diagram power supply with connection to the IO circuit board for device GR 10-CPR .....	56
9.2.6	Terminal diagram I/O circuit board GRD 7 for device GR 10-CPR.....	57
9.2.7	Terminal diagram power supply with connection to the I/O circuit board for device GR 45/100-CPR	58
9.2.8	Terminal diagram I/O circuit board GRD 7 for device GR 45/100-CPR .....	59
9.2.9	Terminal diagram buffer tank GRD 7 for the devices GR 10-CPR and GR 45/100-CPR .....	60
9.2.10	Terminal diagram measuring plate for the devices GR 10-CPR and GR 45/100-CPR.....	60
9.3	Commissioning protocol.....	61
9.4	Operation data sheet.....	62
9.5	Maintenance protocol.....	66
9.6	Spare parts list, wear parts list, consumables .....	67
10	Appendices.....	68

## **Imprint:**

All rights reserved

© Copyright by WDT – Werner Dosiertchnik GmbH & Co KG

Edition: see footer

Reproduction of any kind and translation into other languages, even in excerpts, are only permitted with the express authorisation of the company WDT - Werner Dosierttechnik GmbH & Co. KG.

These operating instructions are an English translation of the original German version by the company WDT.

Responsible for the content:

Co. WDT - Werner Dosierttechnik GmbH & Co. KG

Hettlinger Str. 17

D-86637 Wertingen-Geratshofen

Phone: +49 (0) 82 72 / 9 86 97 – 0

Fax: +49 (0) 82 72 / 9 86 97 – 19

Email: [info@werner-dosierttechnik.de](mailto:info@werner-dosierttechnik.de)

<http://www.werner-dosierttechnik.de>

## 1 About this manual / general

### 1.1 Scope of applicability

This manual describes the function, assembly, commissioning and operation of the device. Read these operating instructions carefully prior to operating the device and keep them in close proximity of the device for immediate use!

**This operating instruction is valid in combination with the operating instructions of the dosing devices:**

- a) **GRANUDOS 10-CPR Touch XL, Nr.: BA SW 002, oder**
- b) **GRANUDOS 45/100 CPR Touch XL, Nr.: BA SW 003, oder**
- c) **CPR Touch XL-2S, Nr.: BA SW 004.**

### 1.2 Target group

This system may only be operated by our authorised partners and persons instructed in the device functions after they have read and understood these operating instructions. Electrical connection work may only be carried out by appropriately trained specialists!

### 1.3 Symbols used

This document uses the following types of safety notices as well as general notices:



#### **DANGER !**

“DANGER” denotes a safety notice whose non-observance may result in immediate, **serious** or **life-threatening injuries** or **significant property damages!**



#### **CAUTION !**

“CAUTION” denotes a safety notice whose non-observance may result in **bodily injury, damages to health** or **property damages!**



#### **ATTENTION !**

"ATTENTION" denotes a safety notice whose non-observance may result in **property damages!**



#### **CAUSTIC !**

"CAUSTIC" denotes a safety notice whose non-observance when handling chemicals may result in **bodily injury** or **property damages.**





## **ESD SENSITIVE !**

“ESD SENSITIVE” denotes electronic components that may be damaged by electrostatic discharge. When handling the devices, the generally known safety precautions for ESD-sensitive devices must be observed!



## **NOTICE !**

A notice denotes information whose non-observance may result in **operational disruptions**.



## **Tip !**

A “Tip” denotes information that may result in **improvements in the operating process**.



## **Mandatory sign**

Use face protection!



## **Mandatory sign**

Use protective gloves! According to DIN EN 374, protective gloves against chemicals and microorganisms



## **Mandatory sign**

Use protective apron!



## **Mandatory sign**

Use protective boots!

## 1.4 Warranty

---

All devices and systems of the Co. WDT are manufactured using state-of-the-art manufacturing methods and are subject to a comprehensive quality control. However, should there be a reason for complaint, any compensation claims shall be directed to the company WDT in accordance with the general terms and conditions of warranty (see below).

### General terms and conditions of warranty

The Co. WDT assumes a 2-year warranty, starting with the commissioning, up to 27 months after delivery; subject to correct installation and commissioning with a completed and signed commissioning protocol.

Exempt from this are wear parts such as gaskets, hoses, membranes, dosing screws, electrodes, roller supports and other parts that are subject to mechanical or chemical wear and tear. For these we assume a warranty of 1/2 year.

Our merchandise management programme requires an invoice for each delivery (including warranty services). When returning a defective component, upon review you will receive a corresponding credit, if applicable. We request a return within 14 days.

The costs for subsequent damages and for the processing of warranty claims are excluded.

There are no warranty claims for damages that were caused by frost, water and electrical overvoltage or by improper handling.



### **Tip !**

**In order to protect the warranty claims, please mail the completed commissioning protocol, along with the defective component, to the Co. WDT. Without the maintenance protocol, we reserve the right to assert a warranty regulation.**



### **CAUTION !**

**It is not permitted to make any modifications to the device. Any violation of this provision voids the warranty obligation as well as the product liability!**

## 1.5 Further information

---

Further information about special topics, e.g., design of the dosing performance or description of the operating parameters, is available from your specialist supplier.

## 1.6 Information regarding support queries

---

The CPR-Touch XL series constitutes a highly complex, electronic control unit. It is subject to continued further development of both its firmware and hardware. We always strive to preserve the compatibility of the components used, but we are unable to guarantee this over a period of several years!

For spare part orders, we therefore always require the following data. You can find these on the nameplate.

- exact device designation
- device serial number
- year of manufacture

For technical support queries, we also require the following data. You can find these in the menu item **Menu → Service → Info**.

- current firmware version
- current hardware version

In the event of problems with the measuring values, we always require all current measuring values. Thus, you can help us in evaluating the disruption more quickly. This will enable us to quickly provide you with help.

## 2 Safety

### 2.1 Intended use

---

The measuring and control unit Touch XL may only be used for the purpose listed in the product description under *Section 3.2, Product description!* In this context, all locally applicable provisions regarding the prevention of accidents, occupational safety and protection of drinking water must be observed!

### 2.2 Safety notices

---

Carefully read and comply with the operating instructions prior to assembly, maintenance and use of the device!

Work on the device and changes in the settings may only be carried out by properly instructed persons!

#### IT safety

The CPR Touch XL controller series allows remote access to data and control parameters by means of network-compatible devices. The operator is responsible for ensuring that only authorised persons can access the device. The operator, or his authorised representative, is further responsible for the safety of all Internet or WLAN connections.

#### 2.2.1 Handling of chemicals, risks to humans and the environment

---

**In case of emergency** when handling chemicals, please contact the Poison Control Centre!

#### **Emergency telephone number:**

#### **Poison Control Centre Munich (or any other poison control centre)**

#### **Phone: +49 89 19240**

#### Excerpt from the Accident Prevention Provisions, GUV-V D 5

Installation rooms for chlorination systems and storage rooms

Section 3a. (1) Chlorination systems must be installed in lockable rooms and the chemicals intended for the chlorination must be stored in lockable rooms.

Re Section 3a Para. 1:

This requirement ensures that chlorination systems and chemicals shall be protected against weather effects and unauthorised access.

(2) Rooms in accordance with Para. 1 must not be intended for the permanent presence of persons.

Re Section 3a Para. 2:

..... A “permanent presence” is given when persons are present in the room for more than 2 hours per day. Repair and maintenance work on the chlorination system are exempt from this.

## 2.2.2 Protective measures and rules of conduct



### **CAUSTIC !**

The control unit **CPR Touch XL** is used to control devices that dose caustic chemicals. Therefore, it is imperative that you observe the safety notices for the respective device!



### **ESD SENSITIVE !**

The electronic components in the devices' controls are sensitive to electrostatic discharge. Therefore, the generally known safety precautions for ESD-sensitive devices must be observed when handling the devices, such as:

- Discharge of personal static charge
- Dissipative clothing
- Disconnect the device from the voltage supply

## 2.2.3 Activation of remote access



### **ATTENTION !**

The device can also be operated via a browser-compatible terminal. (E.g. Smartphone, PC, Tablet) Observe the following safety instructions for remote access!

#### DEFINITIONS:

- Remote access = external use = operation of the device via a network (e.g. Internet, LAN, W-LAN)
- System owner = end user, end client, operator (can also be a legal entity)
- Service partner = dealer = distributor
- User = anyone with remote access ability, e.g. Service partner, IT service provider
- Manufacturer = manufacturer of the device

As the manufacturer of the device, we would like to point out that by activating the remote access you are exposing yourself to common online risks (e.g. hacking, phishing, viruses, Trojans, etc.). Here is some important security advice and rules of conduct to follow when using the remote access.

Please ensure that you have read and implemented the following notices before activating remote access!

#### 1. Personal responsibility

As the party activating remote access, you will be responsible for establishing whether or not the prerequisites for remote access are met and for ensuring disruption-free operation of the system. You are the service partner or owner of the system and you shall bear the consequences of any misuse by third parties.

## 2. User permission

The system owner must ensure that only expert individuals who are familiar with the system, are granted remote access.

The prerequisite for activating remote access, and the associated external use, should be express, written and named permission issued by the system owner. Such permission should be tied to the individual in question and will be non-transferable. In the event of a change of personnel, a new individual must be granted permission.

## 3. Organisational measures regarding availability, integrity and confidentiality

The party who activated the remote access should oblige all users of said remote access to strict confidentiality. All information about technical configurations and organisational information that may be gained via the remote access must be used solely for the purposes thereof.

Each user must ensure that his or her actions do not impact the availability, integrity, or confidentiality of the system.

As system owner, you must oblige all users to notify you immediately if they notice issues or irregularities that are attributable to unauthorised remote access.

## 4. Technical measures to protect against access

As system owner, you must safeguard the system against access by unauthorised parties and block the system immediately upon knowledge of misuse or if remote access is to be discontinued.

Passwords must be treated as confidential and must meet complexity requirements. These requirements can be found in the operating and assembly instructions of the device.

Please be aware that when activating remote access, you must comply with current state-of-the-art technical safety requirements. This particularly applies to confidentiality, network separation, data traffic security (e.g. encrypted) and system security (anti-virus software, firewall, patch status, VPN).

## 5. Third party hardware and software

The manufacturer shall assume no responsibility for disruptions and malfunctions of the device that are caused through external hardware and software.

## 6. No liability for system disruptions caused by remote access by external users

The manufacturer shall not be responsible for disruptions or problems arising as a result of the remote access. Security-relevant disruptions must still be reported to the manufacturer.

This shall in particular apply to:

data loss, the loss of passwords, the detection of malicious software on the computer, the detection of suspicious activities and, in particular, system settings that could endanger people.

The manufacturer shall only provide remote access without security components and shall not accept any liability for loss, damage or costs arising directly or indirectly as a result of the use or unavailability of remote access. In the event of any infringements of legal provisions, the owner of the system alone shall be liable for all direct and indirect losses, damage and costs.

## 7. Availability

The manufacturer does not accept any liability for the availability of remote access.

## **3 Product description - scope of delivery**

### 3.1 Scope of delivery / accessories

The measuring and control unit CPR-Touch XL is delivered with the following standard accessories.

- Buffer solutions pH7, pH4, redox test solution
- Electrode cleaner, distilled water
- Cleaning beads, electrolyte solution, replacement gaskets
- 2 pc. ½“ measuring water ball valve with immersion pipe, (not included with Granudos variants)
- 7m each measuring water pipe 6x1mm of PE and PTFE, (not included with Granudos variants)

In addition, customer-specific or order-related modifications are possible.

### 3.2 Product description

The CPR-Touch XL controller series is intended exclusively for measuring and control tasks for the water treatment in swimming pools. It is used for the following 3 dosing devices:

- GRANUDOS 10-CPR Touch XL
- GRANUDOS 45/100-CPR Touch XL
- CPR Touch XL-2S

The control has the following main functions:

- Regulation of the pH value by means of a hose pump directly from the supply canister
- Regulation of the disinfection dosing, with screw conveyor (type Granudos) or hose pump (type 2S)
- Regulation of the flocculant, by means of a hose pump directly from the supply canister
- Backwash disinfection / high-speed dosing controlled by a switching valve
- ECO operation for lowering the setpoint for free chlorine during extended pause times, e.g., night, weekend, rest day
- Filling of a buffer tank with chlorine solution for disinfecting additional small basins with dosing pumps (option)
- Fault message potential-free
- PC connection, remote display and access to the values and parameters via LAN
- Remote display (optional)

## 3.2.1 Device overview

The control unit CPR-Touch XL is delivered as a ready-assembled unit. All parts are mounted on a plastic plate or on the respective dosing device. This ensures a safe assembly of the device. It also goes toward preventing potential execution errors on the part of the assembly personnel, as far as possible.

For the transport, the factory removed the two electrodes with a glass shaft from the measuring cell and delivered them in a separate packing box. In order to avoid deformation of the dosing hoses during extended storage, the hose pumps' roller supports have been pulled off the motor shaft.

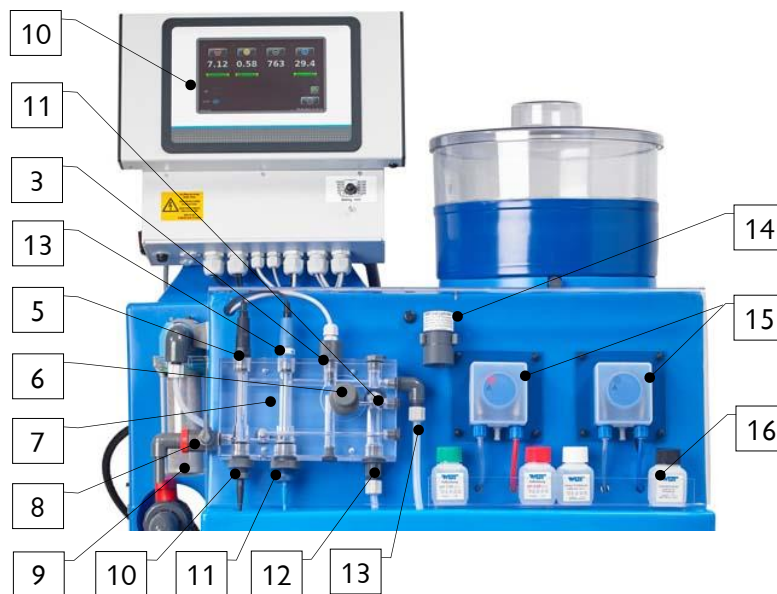

Figure 1, GRANUDOS 10-CPR Touch XL

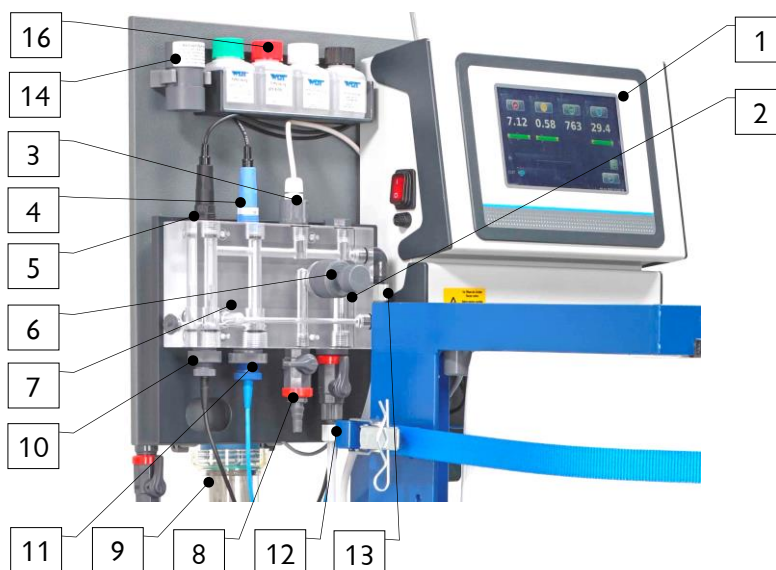
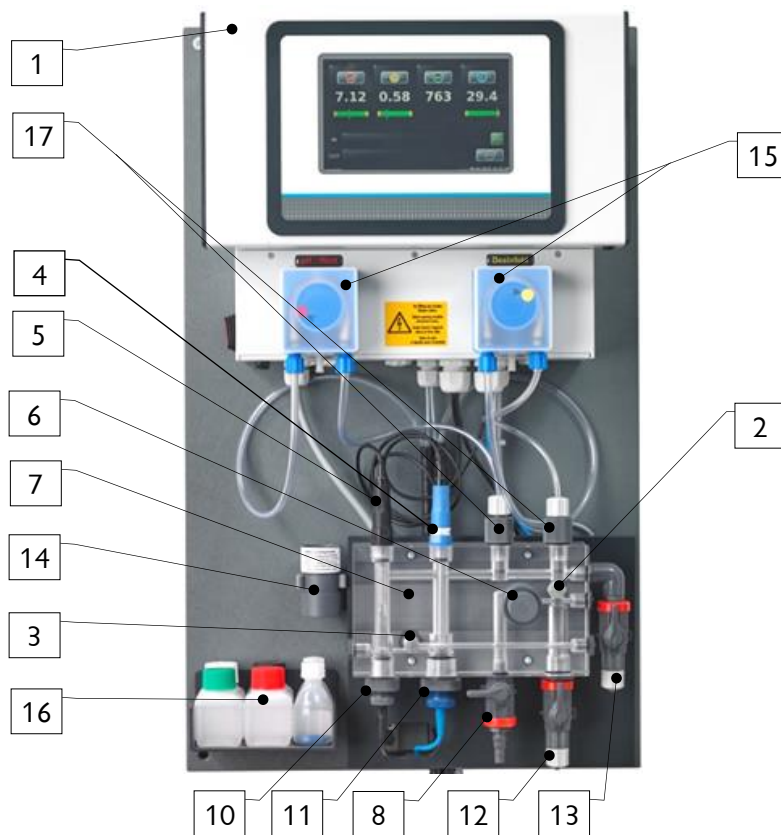

Figure 2, GRANUDOS 45/100-CPR Touch XL





**Figure 3, CPR Touch XL-2S**

1. Control CPR Touch XL
2. Flow monitoring
3. Temperature sensor
4. Combination reference-return electrode (blue)
5. pH electrode (black)
6. Flow control valve
7. PMMA measuring cell block
8. Test water tap
9. Prefilter (with 2S optional for wall mounting)
10. Redox electrode
11. Chlorine electrode
12. Measuring water intake
13. Measuring water return flow
14. Redox test cylinder
15. 2 dosing pumps Sa (for Granudos 45/100 not shown in the figure)
16. Buffer solution and electrode cleaner
17. Dosing valves (only with 2S)
18. Suction kits (not shown in the figure)

---

## 3.2.2 Control CPR Touch XL (standard)

---

The microprocessor-supported control is contained in a dust-proof casing. The start view, also known as “auto mode”, displays the current measuring values, the operating status and the active in- and outputs (IN – OUT). The in- and outputs can be operation messages or fault messages.

## 3.2.3 The measuring cell block

---

The compact measuring cell block (7) is made of acryl glass and serves to hold the electrodes, metering, beads and cleaning of the sampling valve. It is the flow regulated and the test water is led back.

## 3.3 Identification of the device / nameplate

---

For spare part orders and troubleshooting, it is useful to know the device serial number and firmware version. The device serial number is located on the nameplate on the right side of the control casing. The firmware version can be called up via the menu item **Menu** → **Service** → **Info**.

Nameplate see OI Part 1 for the dosing devices

- Granudos 10-CPR Touch XL, No.: BA SW 002
- Granudos 45/100-CPR Touch XL, No.: BA SW 003
- CPR Touch XL-2S, No.: BA SW 004

## 3.4 Technical data

	<u>CPR Touch XL-2S control technology</u>	<u>GRANUDOS 10-CPR control technology</u>
Connection data		
Electric connection data	230VAC/50Hz ± 10%, 35W, I max. 0.2A, standby 22VA, safety (Schukoplug)	230VAC/50Hz ± 10 %, 320W, I max. 1.4A, standby 22VA, safety (Schukoplug)
Protection class	Casing IP54	Casing IP54
Interface connection	Modbus TCP, USB fore data export	Modbus TCP, USB fore data export
Measuring water supply	From the swimming pool cycle	from dosing device
Operating data:		
Measuring range	pH value: 2.00 to 12.00 free chlorine: 0.01 to 2mg/l or 0 to 8.00mg/l, respectively Redox: 0 to 1000mV Temperature: -30.0 to 170.0°C	pH value: 2.00 to 12.00 free chlorine: 0.01 to 2mg/l or 0 to 8.00mg/l, respectively Redox: 0 to 1000mV Temperature: -30.0 to 170.0°C
Medium temperature	0°C to 40°C	0°C to 40°C
Ambient temperature	5°C to 35°C	5°C to 35°C
Humidity engineering room	max. 80% non-condensing	max. 80% non-condensing
Concentration hypochloric acid	—	max. 0.2%
Ventilation of the room (in and out)	According to DIN 19643	According to DIN 19643
Material	Casing: PS Measuring water line: PE Dosing lines: PTFE	Casing: PS Measuring water line: PE
Firmware version	—	—
Hardware version	—	—

	<u>GRANUDOS 45/100-CPR control technology</u>	
Connection data		
Electric connection data	230VAC/50Hz ± 10 %, 320W, I max. 1.4A, standby 22VA, safety (Schukoplug)	
Protection class	Casing IP54	
Interface connection	Modbus TCP, USB fore data export	
Measuring water supply	from dosing device	
Operating data:		
Measuring range	pH value: 2.00 to 12.00 free chlorine: 0.01 to 2mg/l or 0 to 8.00mg/l, respectively Redox: 0 to 1000mV Temperature: -30.0 to 170.0°C	
Medium temperature	0°C to 40°C	
Ambient temperature	5°C to 35°C	
Humidity engineering room	max. 80% non-condensing	
Concentration hypochloric acid	Granudos 45: max. 0.2% Granudos 100: max. 0.35%	
Ventilation of the room (in and out)	According to DIN 19643	
Material	Casing: PS Measuring water line: PE	
Firmware version	—	—
Hardware version	—	—

## 3.5 Transport / storage

Please check the devices immediately upon receipt for potential transport damage.



### **ATTENTION !**

The systems and devices may be damaged by frost or high temperatures. Avoid exposure to frost during transport and storage! Do not store systems and devices next to objects with strong heat emission or in direct sunlight. The device may only be transported and stored in its original packaging. Please ensure careful handling.

### Storage of chemicals



### **NOTICE !**

Please comply with the chemicals manufacturer's safety data sheets!

In addition, please observe the provision regarding the storage of chemicals TRGS 515.

## 4 **Assembly**

### 4.1 Select the installation site

---

See operating instructions Part 1 Dosing technology, regarding the respective dosing device.

### 4.2 Assembly instructions / installation suggestion

---

See operating instructions Part 1 Dosing technology, regarding the respective dosing device.

### 4.3 Mechanical assembly

---

See operating instructions Part 1 Dosing technology, regarding the respective dosing device.

### 4.4 Hydraulic assembly

---

See operating instructions Part 1 Dosing technology, regarding the respective dosing device.

### 4.5 Electric assembly

---

See operating instructions Part 1 Dosing technology, regarding the respective dosing device.

## 5 Commissioning

### 5.1 Commissioning, - comments

The work described here may only be carried out by trained specialist personnel from a specialist company. Prior to commissioning, the installed devices must be checked for proper installation and leaks.

Please use the commissioning protocol from *Section 9.3* for the commissioning. The device was delivered with specific factory settings. You can find the setting values in the operation data sheet under *Section 9.4*.



### **NOTICE !**

**Please ensure that all hose screw connections of the measuring water pipes are firmly tightened. Check all screw connections on the device and on the two measuring water ball valves 1/2". Plastic screw connections may only be fastened hand-tight!**

### 5.2 Commissioning tasks

Carry out the commissioning tasks in the sequence indicated.

#### 5.2.1 Insert the cleaning beads

The included blue glass beads serve for cleaning the two metal electrodes screwed in from below (pos. 10 and 11). This concerns the chlorine and redox electrodes. Fill the measuring cell from above with a sufficient number of glass beads to ensure that at least the metal surface is covered, 20 to 30 pieces.



**Figure 4, measuring cell block and cleaning beads**

## 5.2.2 Insert pH and combination electrodes with glass shafts

Remove the two electrodes with glass shafts from the packing box and pull off the protective cap. The union nut of the electrode cables can be removed from the electrodes by twisting to the left. The electrodes are screwed into the measuring cell from above at position 4 (blue) and position 5 (black). Subsequently, the electrode plug must be placed back onto the respective electrode and the union nut must be tightened.

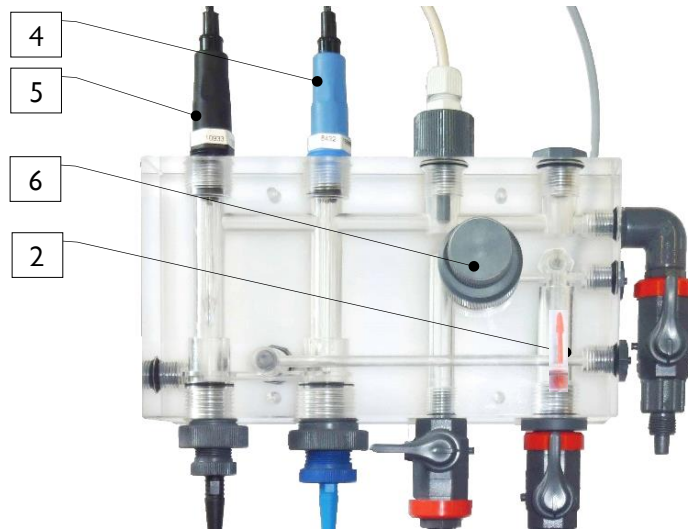

Figure 5, measuring cell block with installed electrodes

## 5.2.3 Set the measuring cell flow rate

Once all electrodes have been screwed hand-tight into the measuring cell and the measuring water pipes have been connected, the measuring water intake may be opened. The flow volume can be adjusted at the flow control valve (pos. 6). The flow mounting float (pos. 2) must be pushed toward the top in order to release the dosing. The cleaning beads must rotate extensively on the metal surfaces. A flow rate that is set too high causes the cleaning beads to lift off the surface, thus diminishing their cleaning efficiency.

## 5.2.4 The control parameters

The device is loaded with factory-defined control parameters. Please adjust the control parameters for your basin according to the required dosing performance and the desired setpoints.



### **NOTICE !**

**Following a temperature adjustment and inflow time of approx. one hour, the electrodes must be calibrated.**

The mechanical commissioning is now completed. Continue with *Section 6, Operation and service* of the device in order to adjust the control parameters to your swimming pool and to optimise them.

## 6 Operation / service



### **NOTICE !**

**The nationally applicable accident prevention provisions in Germany: Operation of swimming pools BGR/GUV-R 108 must be observed.**

#### 6.1 General

---

Once all preparations for the commissioning have been completed, the settings can be adjusted at the dosing system CPR Touch XL.

#### 6.2 The control unit CPR Touch XL

---

The control unit CPR-Touch XL is equipped with a touch-sensitive display. By touching a symbol or a numeric value, this will be activated for parametrisation. The adjustment menus come with additional text-based instructions.

##### 6.2.1 Operation display - Display auto mode

---

A 7" touch display allows the clear and easy operation of the microprocessor-supported control of the CPR Touch XL. The operating states and disruptions are displayed directly on the start screen: see *Figure 6, auto mode, page 21*.

In the auto mode, the current measuring values, the operating status and the active in- and outputs (IN – OUT) are displayed. The in- and outputs can be operation messages or fault messages.

##### Operating notes:

The operating status is displayed in the status line. The following operating states are available:

- Dosing delay
- Automatic
- Manual dosing
- Menu
- Adjustment
- Output test
- Input test



The device is operated by means of a resistive touch display. Desired parameter changes, calibrations and tests can be done simply by lightly touching the corresponding symbol or the numeric value.

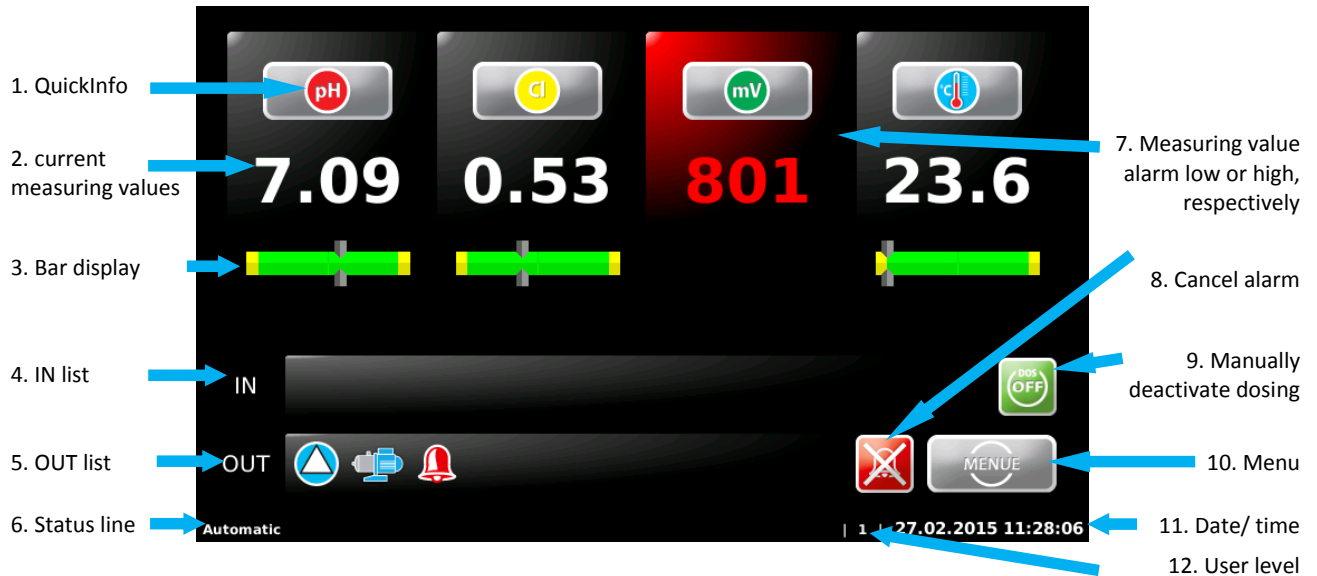











Figure 6, auto mode

The IN list shows the input signals to the control unit.  
The OUT list shows the active output signals of the control unit.

## **Symbols used:**

The symbols depend on the firmware, i.e., the device variant used

### **IN list (general)**

-  red = pH level (container for pH regulation empty)
-  yellow = disinfection level (container for disinfectant empty)
-  blue = flocculation level (container for flocculant empty)
-  Hose rupture – a chemical leak has occurred at one of the installed hose dosing pumps (variant 2S)
-  The measuring cell flow is too low
-  Shock chlorination (filter disinfection) active
-  The request for ECO operation from the central control cabinet is pending.
-  The controller is deactivated via the central control cabinet.  
No dosing, no heating of the basin water, no alarm message takes place.
-  The dosing is blocked by an optional flow switch in the clean water line.  
No dosing takes place



A dynamic dosing time has been exceeded. The respective output is blocked.  
To save space, no differentiation is made between the individual channels!

### **OUT list (general)**



red = pH regulation output active  
yellow = disinfection output active  
blue = flocculation output active



Temperature output active.



The ECO operation is active. Feedback occurs to the central control cabinet regarding the ECO operation



The alarm relay is active.



### **NOTICE !**

**The firmware is available in different device variants. Depending on the scope of functions, a larger or smaller number of icons is displayed in the individual menu items.**

The following symbols are only active in the device variant **GRANUDOS**.

### **IN list (only for Granudos)**



The pressure at the GRANUDOS motive water pump is too low. The motive water pump is being stopped



The level in the GRANUDOS flushing tank is too low. The motive water pump is being stopped



The level in the GRANUDOS flushing tank is too high. The dosing of chlorine and acid is stopped



The flow rate in GRANUDOS is too low. The dosing of chlorine and acid is stopped.



The fuse of the chlorine dosing motor has tripped.

### **OUT list (only for Granudos)**



The motive water pump is active



The knocker is active. This symbol is only displayed very briefly

The following symbols are only of interest in the buffer filling **OPTION**.

## IN list (optional, design with buffer tank)



The buffer filling is started



The buffer filling is terminated



The level in the buffer tank has dropped too low. The dosing of chlorine is stopped



The level in the buffer tank is too high.



The optical sensor at the cyclone did not recognise any chlorine during the buffer filling. The filling was deactivated.



The buffer filling was cancelled by the system. The filling occurred too slowly.

## OUT list (optional, design with buffer tank)



The filling of the buffer tank is active.

## The function buttons on the start screen



Manually cancel the dosing delay, dosing starts



Manually deactivate the dosing for service tasks



Deactivate alarm relay



Call up the main menu

## Operation display:

Depending on the operation state, the display shows different views. The following illustrates and describes the main display views.

## 6.2.2 Automatic operation

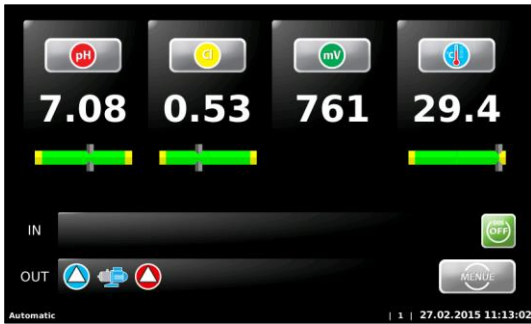

The device is in the operating state Automatic. The auxiliary hygiene parameters and the temperature are regulated based on set parameters.

There is no disruption.

The **Out list** shows the currently active outputs and/or actuators as an example.

## 6.2.3 QuickInfo

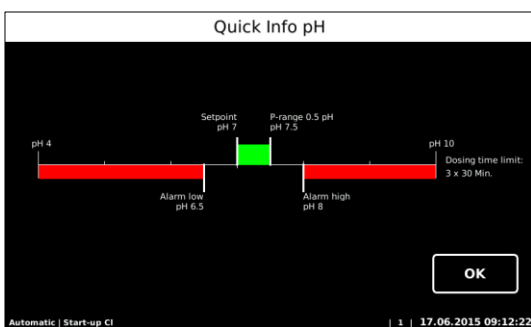

In automatic operation, the set control parameters can be viewed quickly and without a password prompt via the QuickInfo function by touching the corresponding symbol. QuickInfo only serves for the query of the control parameters; no changes can be made.

## 6.2.4 Start - Dosing delay

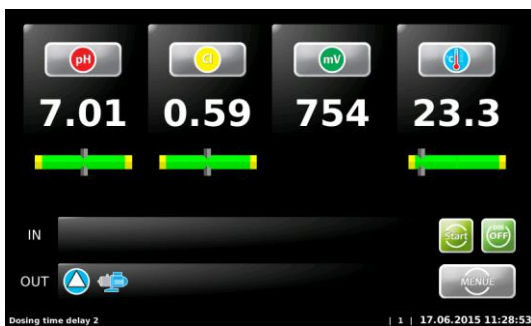

If the device is restarted, the dosing delay is running, during which no dosing output is activated.

Software alarms are suppressed during this time.

The dosing delay must be set high enough to ensure that after the start of the filter system actual basin water flows through the measuring cell.

The dosing delay can be cancelled with  and the device is set to automatic operation.

## 6.2.5 Alarm

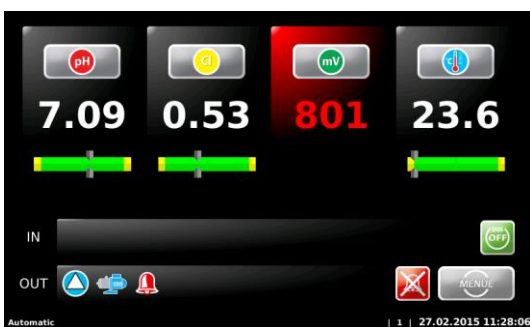

If an alarm occurs, this is signalled by the symbol  in the OUT list. The alarm relay is activated.

A differentiation is made between alarms (software alarms, e.g., alarm high, alarm low) and disruptions (switch inputs).

In the event of measuring value alarms, the respective measuring value is additionally illustrated in red.

In the event of disruptions, the corresponding symbol appears in the **In list**.

Alarms or disruptions must be pending for approx. 5 seconds before an alarm is triggered.

With the  button, the alarm can be temporarily deactivated without remedying the disruption. If a subsequent disruption occurs, the alarm relay will be reactivated.



## Tip !

An alarm will be automatically deleted when its cause has been remedied. This is the case, e.g., if the empty chemical container was replaced or if measuring water resumes its flow through the measuring cell.

However, the alarm **Switch-off time monitoring** must be acknowledged manually!

### 6.2.6 Automatic - Startup

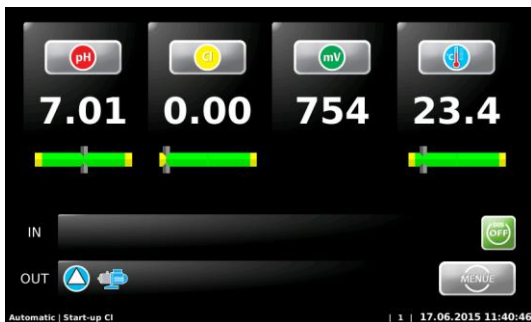

If one of the two measuring values pH or Cl falls outside the control range, the start routine Startup is started.

During the start routine, the dynamic dosing time monitoring is active. If a measuring value does not reach the control range within the selected time, e.g., due to a malfunction, the dosing stops with an alarm.

The dosing time monitoring alarm is signalled by . This malfunction is only reset through a device restart or a manual acknowledgement.

### 6.2.7 Automatic – Redox control (emergency programme)

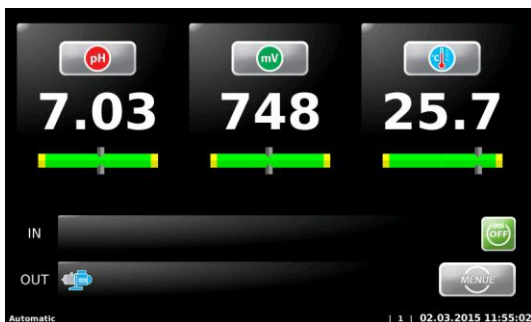

In the event of an irreparable defect in the measuring of free chlorine, e.g., a broken electrode, the disinfection dosing for temporary operation may be done via the emergency function of the redox control.

If this operation mode is selected, the display in the start screen changes.

The measuring value for free chlorine is faded out.

### 6.2.8 Manual dosing (emergency programme)

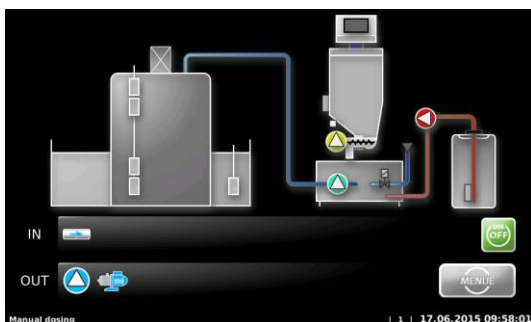

In the event of an irreparable defect in the general measuring technology, both the disinfection dosing and the dosing of the pH regulation for temporary operation may be done via the emergency function Manual operation.

If this operation mode is selected (see Section 6.2.9.3), the display in the start screen changes.

For type Granudos: Instead of the measuring values, a flow chart of a Granudos dosing device with a buffer tank is displayed.



For type 2S: The measuring values are faded out.

## The main menu

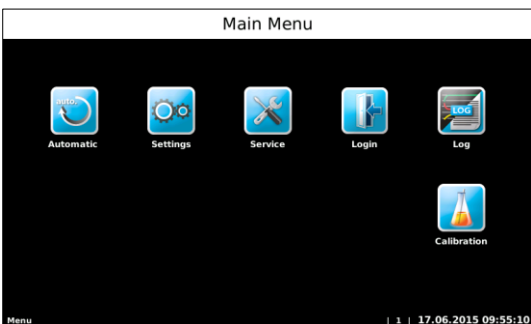

### Automatic

Navigates to the start screen and automatic operation



### Settings

For adjusting the control parameters and system settings



### Service

Input and output test, info



### Login

For the password assignment; no password is assigned in the delivery state.



### Log

For the query of events and data logging



### Calibration

Calibration of the pH and redox electrode, DPD1 calibration

## 6.2.9 Main menu → Settings (overview)

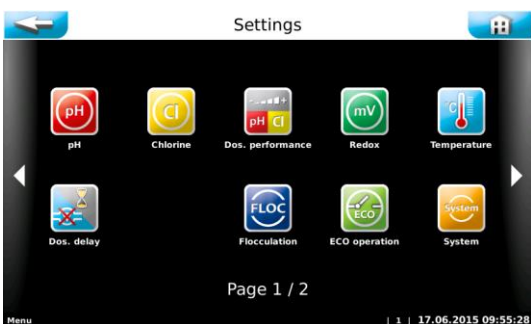

In the Settings menu, you can adjust the desired settings for the dosing device. Using the white arrow keys on the side, you can navigate to the next screen menu.



### pH

Set pH control parameter



### Chlorine disinfection

Set disinfection control parameter



### Dosing performance

Adjust the dosing performance to the basin size



### mV - Redox

Set redox voltage control parameter

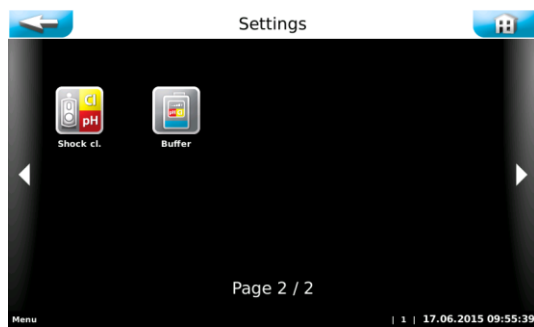

## Temperature

Set basin temperature control parameters



## Dosing delay

Set the dosing delay



## Flocculation

Set flocculation dosing parameter



## ECO operation

Set parameter for ECO operation



## System

Set date/ time, password, display, network and language



## Shock chlorination

Set dosing performance for the Shock chlorination function



## Buffer (Buffer tank, only for Granudos)

Set dosing performance for the Buffer filling function



## NOTICE !

After a password has been assigned, the controller is blocked against unauthorised access. The setting buttons will appear in grey. Desired changes can only be made after the password has been entered. After a password has been assigned, please enter it in the operation data sheet.

### 6.2.9.1 Main menu → Settings → pH

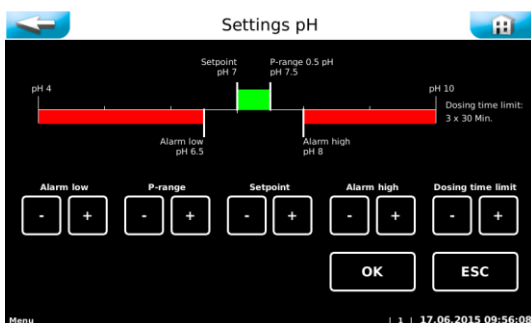

Alarm low: → lower alarm value

P range: → The dosing works proportionally, i.e., the higher the difference between setpoint and actual value, the longer the dosing time (max. 8 seconds).

The smaller the selected control range, the faster the measuring value will react, which can easily lead to overdosing.

Setpoint: → the device attempts to reach this value

Alarm high: → upper alarm value

Dosing time limit: → if the control range is not reached within three x the set time, the dosing is blocked.

**Important:** This disruption must be acknowledged manually!



## Tip !

**pH priority dosing! To protect against overdosing with disinfectants that contain chlorine, the dosing is only released once the pH value**

**has entered the control range. For this reason the control range must not be set too high.**

## 6.2.9.2 Main menu → Settings → Disinfection chlorine

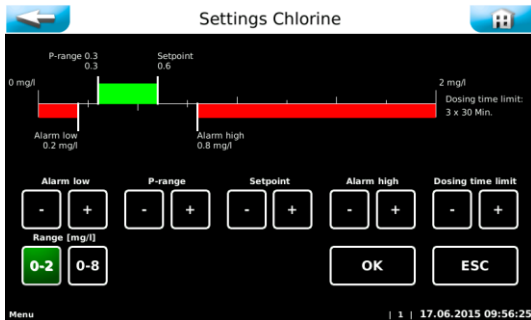

Alarm low: → lower alarm value

P range: → The dosing works proportionally, i.e., the higher the difference between setpoint and actual value, the longer the dosing time (max. 15 seconds).

The smaller the selected control range, the faster the measuring value will react, which can easily lead to overdosing.

Setpoint: → the device attempts to reach this value

Alarm high: → upper alarm value

Dosing time limit: → if the control range is not reached within three x the set time, the dosing is blocked.

**Important!** This disruption must be acknowledged manually!

## 6.2.9.3 Main menu → Settings → Dosing performance

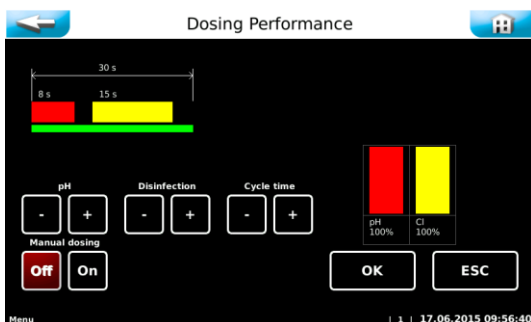

The Dosing performance menu serves for adjusting the dosing performance to the expected consumption of chemicals in the pool.

Especially in case of lower water content, it is very important to adjust the dosing performance.

The required dosing performance depends on several factors, e.g., the basin volume, location, type of use and of course the frequency of use by pool visitors.

pH: → Acid dosing time in seconds

Disinfection: → Chlorine dosing time in seconds

Cycle time: → Length of the overall cycle in seconds

Manual dosing: → Change between automatic and manual dosing

### Explanation regarding the cycle time

The shortest cycle time is 30 seconds, i.e., every 30 seconds the dosing is proportionally activated for a varying length of time, depending on the deviation from the setpoint.

It can be set for a dosing time between 1 and 8 seconds for the acid dosing, followed by a pause of 4 seconds. This is followed by a dosing time between 1 and 15 seconds for the chlorine dosing, followed by a pause of 3 seconds.

This is followed by an additional pause time until the entire cycle time has elapsed. An extension of the cycle time extends the second pause time, thus reducing the maximum available dosing performance. This will be shown in %.



Example 1: 30 seconds

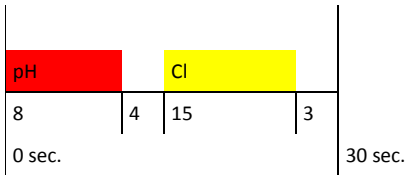

Example 2: 90 seconds

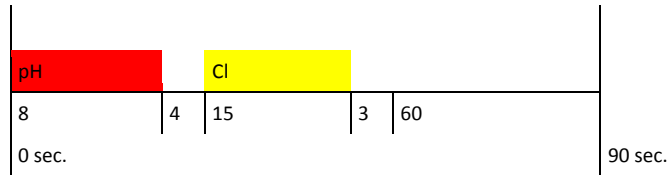

## **ATTENTION !**

The use of sulphuric acid is generally possible up to a concentration of 50%. For higher concentrations or when using other acids (e.g., hydrochloric acid, dissolved sodium bisulphate, etc.), the changed dosing performance and/or increased corrosiveness must be observed! We recommend to consult with the company WDT!

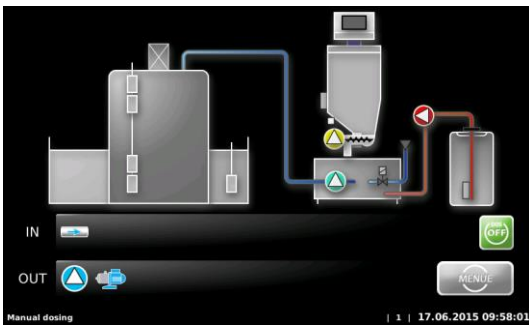

### Manual dosing Off On

There is the option of switching to a continuous manual dosing. This may be necessary in the event of an irreparable defect in the measuring technology, e.g., a broken electrode. For a limited period of time, both the disinfection dosing and the dosing of the pH regulation may be done via the emergency function Manual operation.

After activation of Manual dosing, the display in the start screen changes.

For Granudos: Instead of the measuring values, a flow chart of a dosing device with a buffer tank is displayed.



For type 2S: The measuring values are faded out.

In the operation mode Manual dosing, it is essential to adjust the dosing performance to the actual consumption. It is a known fact that the consumption changes between the operating phases bathing operation and non-bathing operation, e.g., at night or on rest days.



## **CAUTION !**

In the operation mode Manual dosing, the operating personnel must continually check the water quality and adjust the dosing amounts. Non-compliance with this may result in significant overdosing!

## 6.2.9.4 Main menu → Settings → mV Redox - Alarm values

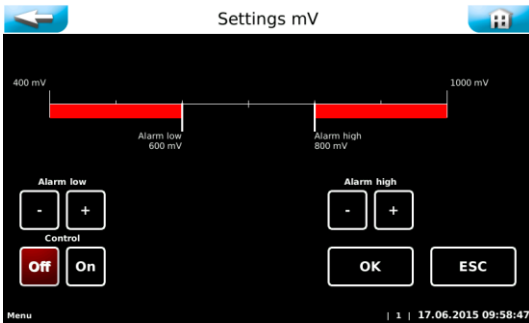

Alarm low: → lower alarm value  
 Alarm high: → upper alarm value  
 Off - On: → select disinfection dosing via redox control (emergency operation)

## 6.2.9.5 Main menu → Settings → mV Redox - Emergency operation

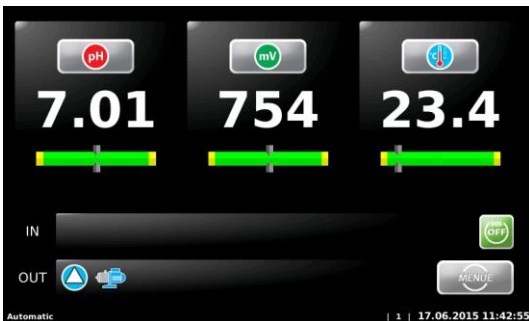

In the event of an irreparable defect in the measuring of free chlorine, the disinfection dosing for temporary operation may be done via the emergency function of the redox control. If this operation mode is selected, the display in the automatic operation changes. The measuring value for free chlorine is faded out.

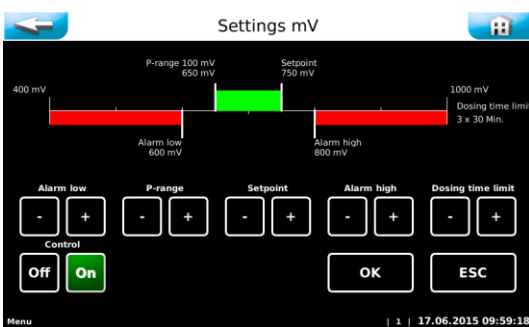

Alarm low: → lower alarm value  
 P range: → The dosing works proportionally, i.e., the higher the difference between setpoint and actual value, the longer the dosing time (max. 15 seconds). The smaller the selected control range, the faster the measuring value will react, which can easily lead to overdosing.  
 Setpoint: → the device attempts to reach this value  
 Alarm high: → upper alarm value  
 Dosing time limit: → if the control range is not reached within three x the set time, the dosing is blocked.  
**Important!** This disruption must be acknowledged manually!

## 6.2.9.6 Main menu → Settings → Temperature

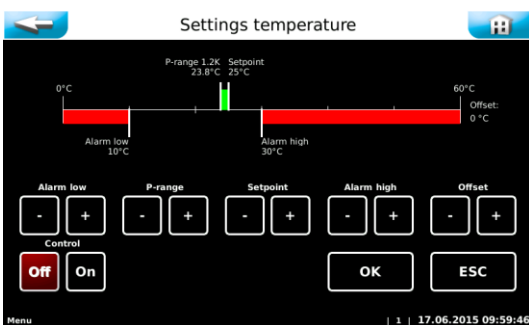

Alarm low: → lower alarm value  
 Setpoint: → the device attempts to reach this value  
 Control range: → if the temperature falls below the setpoint minus the control range (hysteresis), the Temperature output will be activated  
 Example: → Setpoint 25°C – 2.0K → actual value ≤ 23°C = output active  
 Alarm high: → upper alarm value  
 Offset: → for fine-tuning the temperature display  
 Off - On: → operation mode Temperature display or Regulation on-off

## 6.2.9.7 Main menu → Settings → Dosing delay

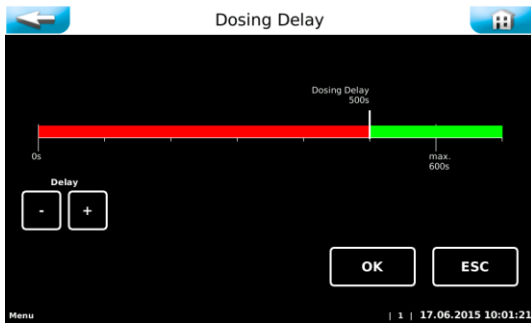

If the device is restarted, the dosing delay is running. No dosing occurs during this time, so that no stale water will be used for the measurement. Software alarms are suppressed during this time. The dosing delay must be set high enough to ensure that after the start of the filter system actual basin water flows through the measuring cell.

## 6.2.9.8 Main menu → Settings → Flocculation

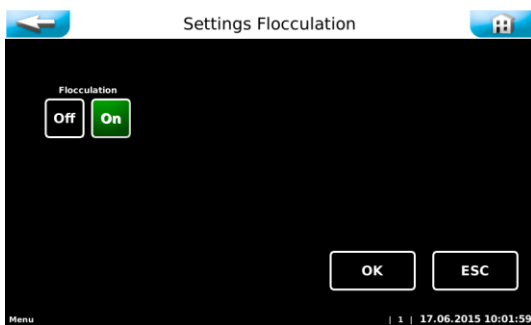

This menu allows the activation or deactivation of the flocculation pump. The dosing release of the flocculation is monitored by the control unit.

## 6.2.9.9 Main menu → Settings → ECO operation – Night-time operation (DIN contact)

The ECO function enables an operation with optimised energy cost and consumption. There are two operation modes: the Master and the Slave operation.

### Operation mode: Master

In the Master operation mode, the controller switches to night-time operation in accordance with the time blocks selected in the Times menu.

### Operation mode: Slave

In the Slave operation mode, a signal from the central swimming pool control initiates the ECO operation.

The ECO output (DIN contact) serves for feedback to the central swimming pool control. It may be used for reducing the circulation volume. The feedback only occurs if the switching threshold of the redox voltage has been exceeded.

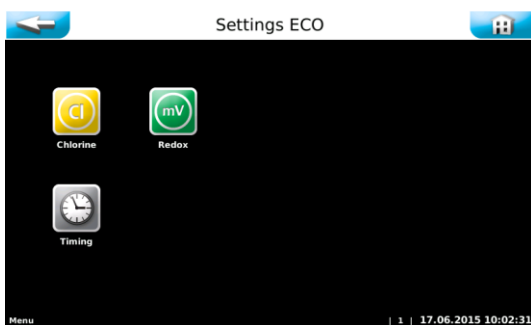

Chlorine: → second parameter set for the reduced setpoint mV – Redox: → Switching threshold for the DIN release contact in Slave operation mode.

Times: → Implemented week timer to specify the night-time operation times.

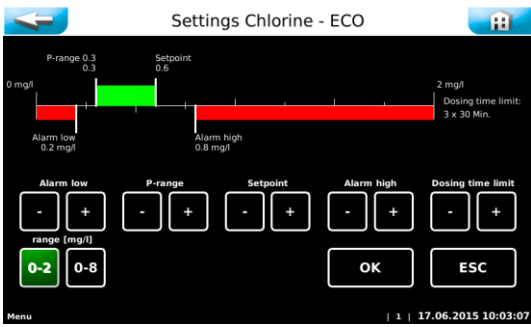

A second parameter set is available for the optimisation of the consumption of the chemical chlorine. A reduced setpoint reduces the consumption of disinfectant.

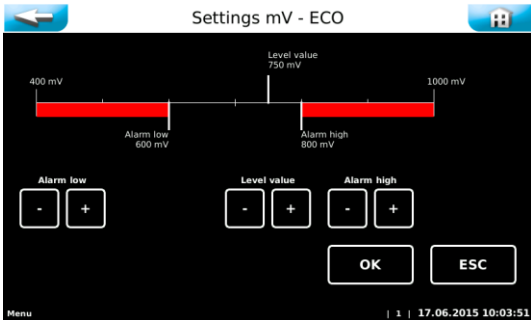

Since the night-time operation should only be initiated at a reasonable level of water quality, a switching threshold is specified for the redox voltage.

The controller will only switch to night-time operation if the actual value  $\geq$  the level value.

If the redox voltage drops below the switching threshold during the night-time operation, the night-time operation is terminated



The figure graphically displays the set switching times for the ECO operation.

The green bars show the set time blocks. In addition, the green check mark indicates that the switching times have been activated for this day.

While the red bar indicates a set time block, the day is deactivated.

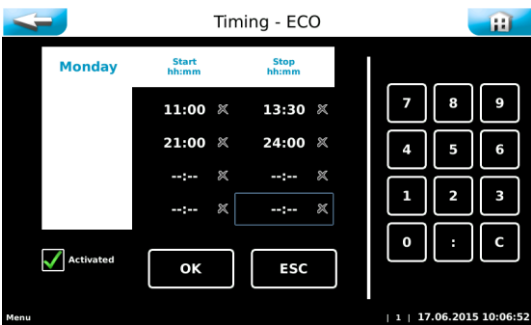

There are 4 time blocks available for each day. Times can be selected between 00:00 and 24:00. The colon must be entered as well!

Times that cover more than one day must be entered as two blocks for both days.

**Example:**

A desired night-time operation between Mon 21:00 and Tue 06:00

Required settings: Mon 21:00 to 24:00 and Tue 00:00 to 06:00

## 6.2.9.10 Main menu → Settings → System



### Date/ time

Set date and time



### Password

Assign a password



### Display brightness

Adjust the display brightness to the ambient conditions



### Network

Set network parameters



### Language

Select the user language

### a) Main menu → Settings → System → Date/ time

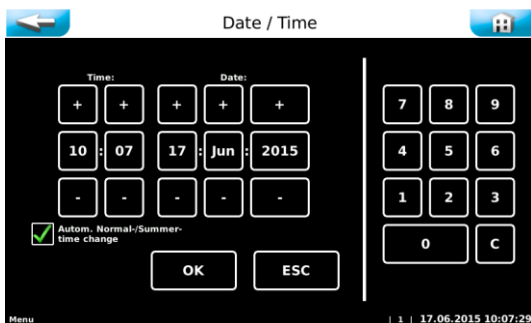

Adjust date and time.

You can activate the automatic switch from winter time to summer time.

### b) Main menu → Settings → System → Password

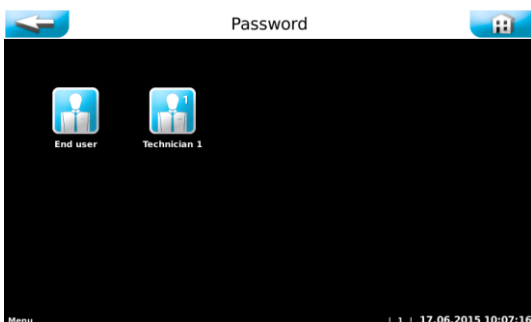

#### End user

There is no factory setting for an end user password. We recommend the assignment of an end user password to protect the system against unauthorised access. Enter the password in the operation data sheet.

#### Technician 1

The Technician 1 password consists of five digits and has a factory default setting of 01234. This password is intended for service partners. We recommend that you change this password as well and enter it in the operation data sheet.

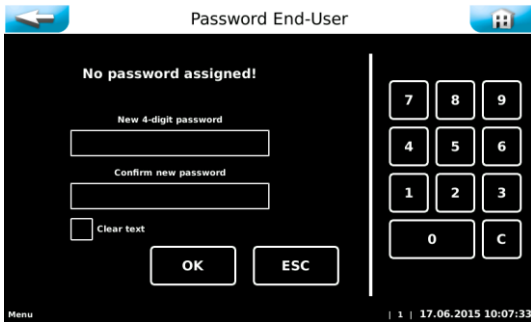

The individual end user password must consist of four digits between 0000 and 9999. In the second line, the password must be entered once again.

If you place a green check mark next to Clear text, the entered numbers are shown instead of white dots.

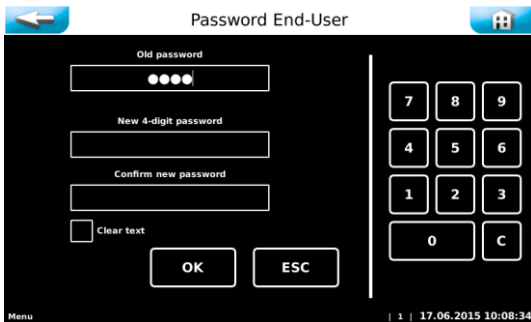

In order to change the current end user password, it must be entered in the uppermost line. The new password must be entered in the two following lines.

If you want to delete the end user password, you only have to enter the active password in the uppermost line. The other two lines remain clear.

When a wrong password is entered, an error message displays.



## **NOTICE!**

**Please store the individually chosen passwords safely in the operation data sheet. Lost passwords can only be reset by the factory customer service!**

c) Main menu → Settings → System → Display

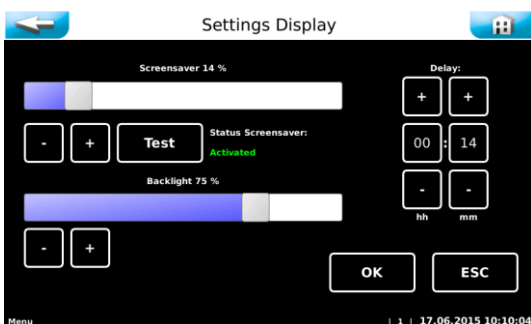

After the selected delay time, the screensaver dims the background lighting to the configured brightness.

The Backlight setting permanently reduces the background lighting in the operation mode.



## **NOTICE!**

**Please reduce the background lighting to the minimal brightness required by you. This significantly increases the lifespan of the background lighting.**

## d) Main menu → Settings → System → Network

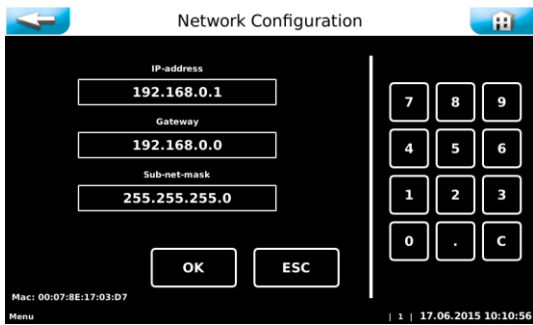

The touch panel contains a LAN interface with an RJ45 socket. Via this interface, the current measuring values and status messages can be transmitted to an external remote display. The terminal device can be a PC monitor, a tablet PC or a smartphone, e.g.

Further information about this topic is available upon request. The operator must establish the necessary IT requirements for remote access! (e.g., VNP connection, data security, etc.)

## e) Main menu → Settings → System → Language



Select your desired operator language.

## 6.2.9.11 Main menu → Settings → Shock chlorination

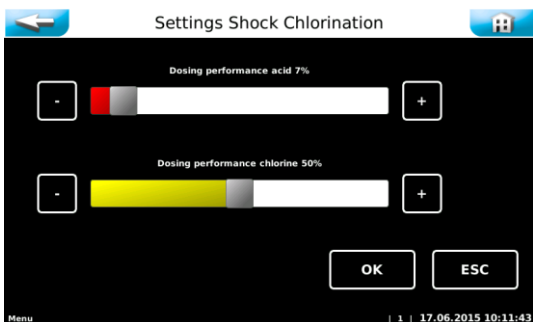

With this menu you can adjust the dosing performance during a shock chlorination. Please select a dosing performance that ensures the availability of the desired concentration during the shock chlorination.

For control purposes, the concentration must be determined repeatedly during the shock chlorination by means of photometry!

## 6.2.9.12 Main menu → Settings → Buffer tank (for Granudos, optional)

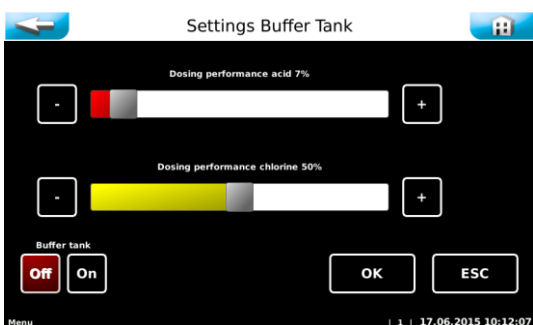

With this menu you can adjust the dosing performance during a buffer tank filling. Please select a dosing performance that ensures the availability of the desired concentration in the buffer tank after the buffer filling. For control purposes, the concentration must be analytically determined repeatedly after the buffer tank filling!

Off - On: → permanently activate or deactivate the Buffer tank filling function. The filling is regulated automatically via the level control in the buffer tank.

## 6.2.10 Main menu → Service

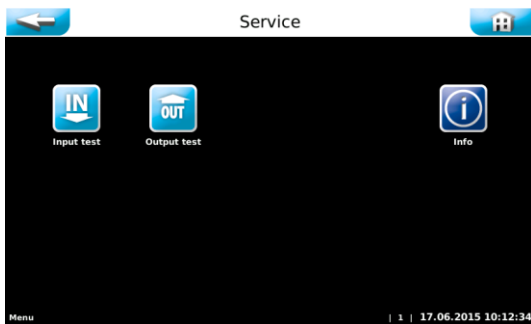

### Input test

A test programme for switch inputs (electrical signals).



### Output test

A test programme for pumps and relay outputs.



### Info

For querying the firmware versions.

### 6.2.10.1 Main menu → Service → Input test

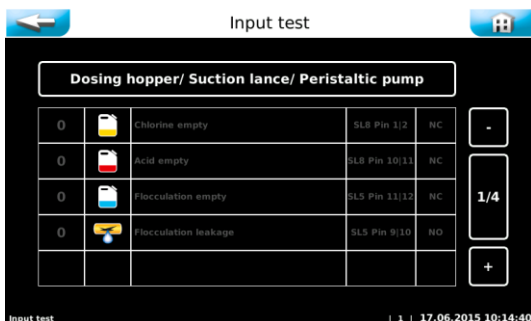

The input test serves for checking the connected inputs (switches). The changing activation of the switch inputs is indicated by 0 (open) or 1 (closed).

The fourth column displays the pin header (SLx) and the connectors (Pinx/x) to which the switch is connected.

The fifth column shows the function of the switches NO or NC, respectively.

NO (normally open) indicates open in the operation state and closed in the event of a disruption.

NC (normally closed) indicates closed in the operation state and open in the event of a disruption.

Use the + and - buttons to flip through the pages.

### 6.2.10.2 Main menu → Service → Output test

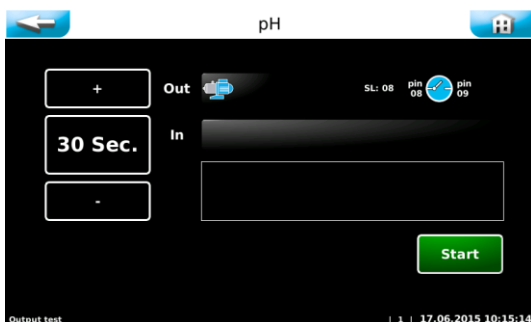

The output test serves for checking the connected outputs (pumps and relays). The selected output is activated for 30 seconds. The activation may be cancelled at any time with the **Stop** button.

For safety reasons (generation of chlorine gas), the output test for the chemical-dosing outputs is only released if no disruption exists that could prevent the dosing.



## 6.2.10.3 Main menu → Service → Info



Info allows you to query the currently used software versions.

A differentiation is made between  
DSP version: The firmware version

I/O version: The version of the co-processor on the I/O board

HTTP version: The web front end version (software version of the user interface).

## 6.2.11 Main menu Login

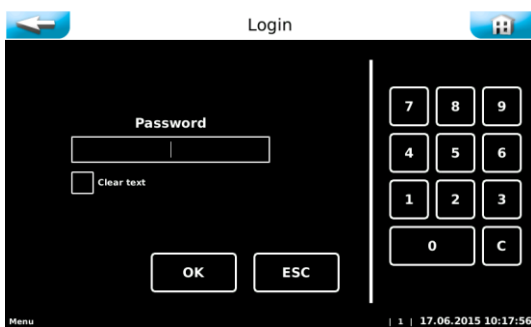

A personal password assigned under Settings → System → Password protects the controller against unauthorised access. Without password, no further settings, calibrations, output tests, etc., are possible. You can still browse the menu and view the data logging.

For future changes and adjustments, you must sign in with your personal password under Login. If you switch to the start screen, the password must be re-entered.

## 6.2.12 Main menu → Log (event and data logging)



### Event Log

Displays a chronological list of the events that occurred



### Data Log

Traces the measuring values in the form of a table or graph



### Export

Serves for exporting the collected data to a USB stick



### Delete

Serves to delete the stored data

## 6.2.12.1 Main menu → Log → Event Log

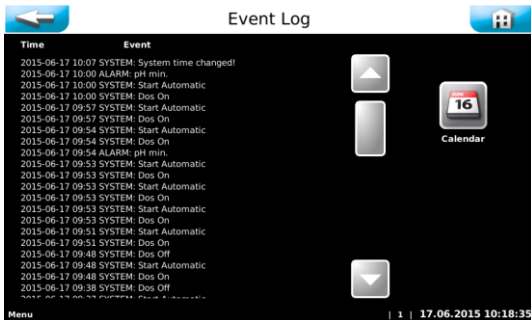

When calling up the menu, a list of events that occurred on this day will be displayed.

You can use the Calendar ICON to view events from previous days.

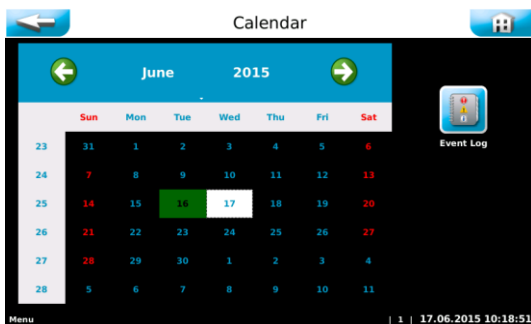

The current day is shown on a white background. Days on which the control was activated are shown on a green background. If you select another day by touching it, that day will be shown on a white background. You can use the Event Log ICON to view the events of the selected day.

## 6.2.12.2 Main menu → Log → Data Log

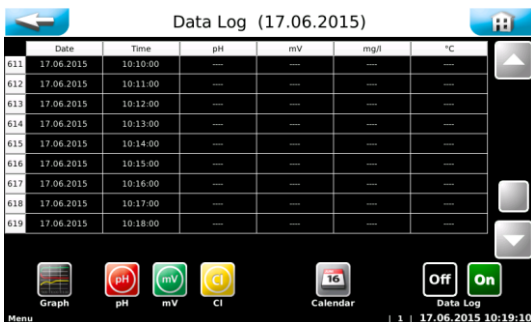

If Data Log is activated, the measuring values are recorded every minute. The measuring values can be traced in the form of a table or graph.

Use the arrow keys to navigate up or down through the pages.

## 6.2.12.3 Main menu → Log → Export

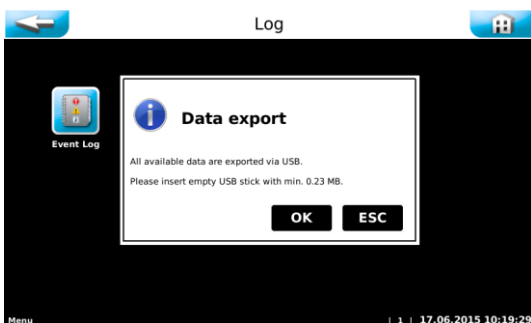

You can use the Export menu item to load the stored log files onto an **empty** USB stick. If the USB stick is not empty, formatting is suggested and will be carried out after you confirm with OK.

The USB stick will subsequently contain the daily event files and the CSV files.

## 6.2.12.4 Main menu → Log → Delete

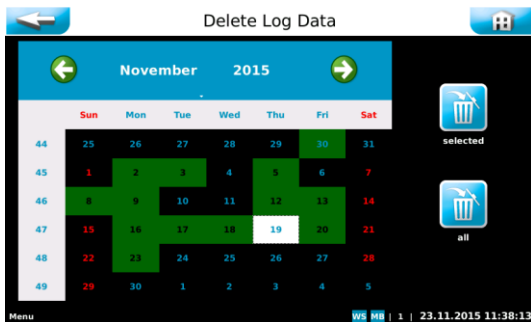

The current day is shown on a white background. Days on which the log files were stored are shown on a green background. If you select the desired day by touching it, that day will be shown on a white background. You can use the Selected ICON to delete the event log events and the data log events of the selected day.

With the ICON, all event log events and data log events can be deleted at once.

## 6.2.13 Main menu → Calibration



**pH**

Two-point calibration of the pH electrode



**phenol red**

One-point calibration of the pH display



**DPD1**

Calibration of the free chlorine display



**mV - Redox**

Calibration of the redox measurement

The calibrations are graphically guided and are accompanied by a help text. Use the  button to acknowledge the completed steps.

### 6.2.13.1 Main menu → Calibration → pH electrode

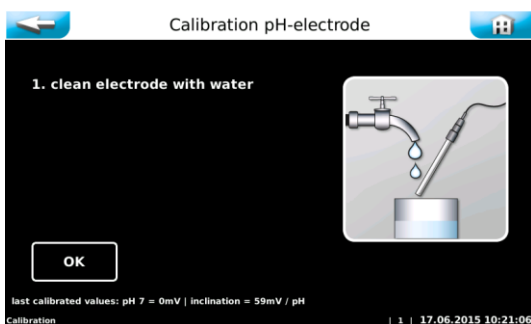

Carry out the calibration according to the instructions.

At the end of the pH calibration, the measuring results of the offset voltage and the conductance voltage are displayed and an electrode evaluation is carried out. In case of minor deviations, the calibration is adopted immediately. In case of "medium" deviations, a cleaning notice is displayed. In case of major deviations, the exchange of the pH electrode is suggested. If the exchange of the electrode does not remedy the problem, the fault may be with the electrode cable or the measuring amplifier.

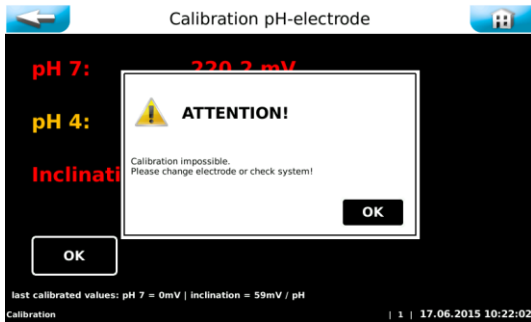

**pH7** = buffer solution for determining the offset voltage.  
The optimal offset voltage is at 0mV up to +/-30mV.

**pH4** = second buffer solution for determining the conductance voltage.

**Inclination mV/pH** = conductance voltage  
The optimal conductance voltage at 25°C is at approx. 59mV/pH.

Example: (pH7 – pH4 = 3pH x 59mV = 177mV)



## **NOTICE !**

### **Notice regarding the evaluation of the electrodes**

#### Cleaning notice

At an offset voltage > +/-41mV, the voltage value is shown in **yellow** and the calibration ends with a cleaning notice.

At a calibration voltage < 52 mV or > 63mV/pH, the voltage value is shown in **yellow** and the calibration ends with a cleaning notice.

#### Error notice

At an offset voltage > +/-61mV, the voltage value is shown in **red** and the calibration is rejected with an error notice!

At a calibration voltage < 50mV or > 65mV/pH, the voltage value is shown in **red** and the calibration is rejected with an error notice!

If the calibration is rejected with an error notice, the device continues the regulation using the values from the most recent successful calibration.

It is necessary to investigate the cause of the failed calibration!

#### Notice regarding the phenol red calibration

A two-point calibration of the pH electrode overrides the most recent phenol red calibration.

### 6.2.13.2 Main menu → Calibration → Phenol red

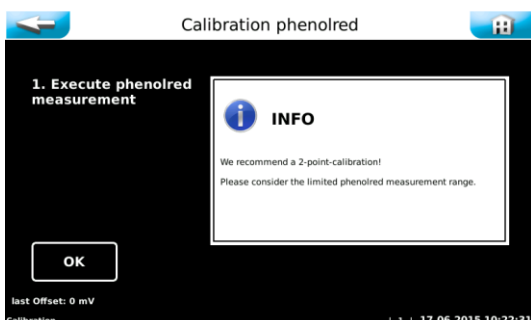

Carry out the calibration according to the instructions.

Please observe the displayed notices and follow the menu navigation.



At the end of the menu, the set deviation is shown as Offset. In case of minor deviations, the calibration is adopted immediately.

In case of deviations larger than **+/- 41mV**, a cleaning notice is displayed.

In case of deviations larger than **+/- 61mV**, the exchange of the pH electrode is suggested. If the exchange of the electrode does not remedy the problem, the fault may be with the electrode cable or the measuring amplifier.

## 6.2.13.3 Main menu → Calibration → DPD1 free chlorine

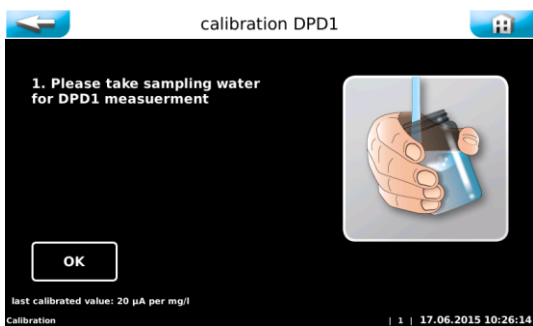

During the first step of the DPD1 calibration, three illustrations are displayed in sequence. They show an example of the procedure for a DPD1 measurement by means of a photometer and tablet measuring.

The exact procedure is explained in the operation manual of your control measuring device!

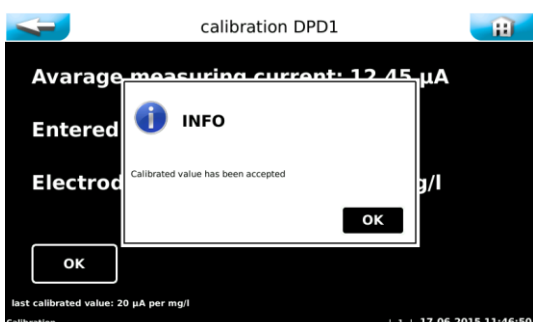
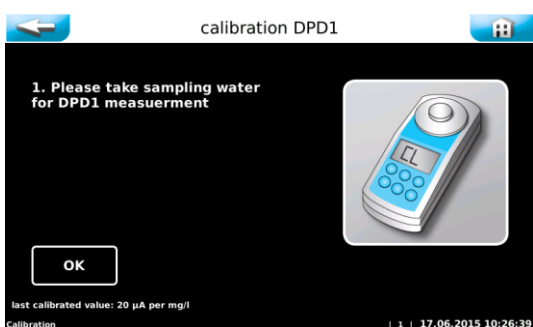
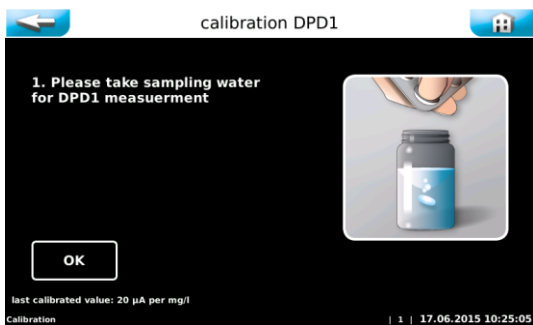

At the end of the menu, the chlorine measuring current, the DPD1 value entered by you and the resulting electrode signal are displayed.

Depending on the water quality, an electrode signal between 10 and 30 µA/mg/l will be shown. If the electrode signal is too weak, the calibration will be rejected with an error message.

## 6.2.13.4 Main menu → Calibration → mV Redox

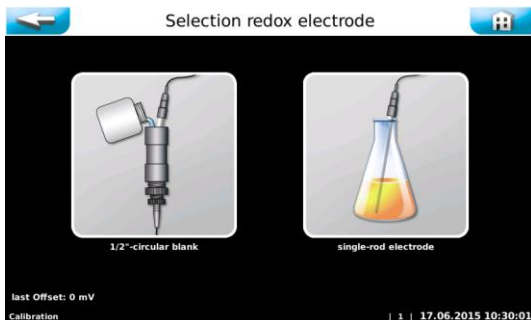

There are two basically different types of redox electrodes. There is the normal redox combination electrode (electrode with a glass shaft) and the ½“ Redox electrode preferred by WDT.

Select the type of electrode used.

The calibrations are explained graphically and with a help text.

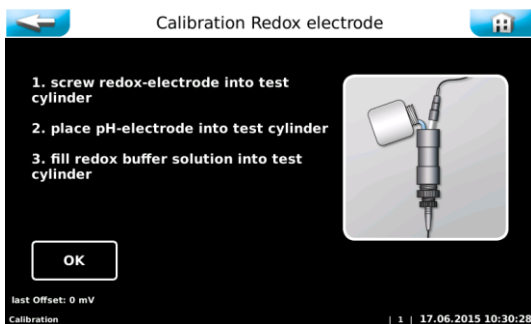

The menu Calibration → Redox electrode enables a fine-tuning of the redox measuring. The redox test solution supplied by WDT supplies a voltage of 468mV at 25°C, see bottle label.

Since the voltage can be chosen freely, the fine-tuning may also be done with other redox test solutions, e.g., 220mV or 640mV.

When making a comparison, please note the temperature dependence of the test solution! See label.



At the end of the menu, the set deviation is shown as Offset. In case of minor deviations, the calibration is adopted immediately.

In case of deviations larger than **+/- 41mV**, a cleaning notice is displayed.

In case of deviations larger than **+/- 61mV**, the exchange of the *pH electrode* is suggested. If the exchange of the electrode does not remedy the problem, the fault may be with the electrode cable or the measuring amplifier.



### **NOTICE !**

**The redox electrode does not deliver a reliable measuring signal after a calibration. A regeneration time of up to two hours is required before a stable redox potential is achieved again!**

## 6.3 Refill consumables

See operating instructions Part 1 regarding the respective dosing device.

- **Granudos 10-CPR Touch XL, No.: BA SW 002**
- **Granudos 45/100-CPR Touch XL, No.: BA SW 003**
- **CPR Touch XL-2S, No.: BA SW 004**

## 7 Maintenance, care, faults

### 7.1 Device maintenance

It is recommended to commission a specialist firm with the regular maintenance. All required maintenance and repair tasks may only be carried out by properly qualified personnel from a specialist company. Required spare parts are available from your specialist supplier.

Please observe the safety notices when handling chemicals and make sure to wear appropriate protective clothing.



#### Tip !

**Please use the maintenance protocol under Section 9.5 for the execution of maintenance tasks. Document these tasks in the maintenance protocol.**

#### 7.1.1 Check and clean the prefilter



**Figure 7, Prefilter**

The prefilter prevents the contamination of the measuring cell. It must be inspected at regular intervals and cleaned as needed. Especially in the spring and fall, a higher level of contamination through flying seeds and falling leaves can occur in outdoor pools. During these times, shorter cleaning intervals must be applied.

When working on lines that carry water, always close the in- and outlet valves! Place a bucket under the filter. Unscrew the filter hood from the bracket. Remove the filter insert from the filter hood and wash the filter insert under running water. Reinstall in the reverse order.



#### NOTICE !

**A soiled prefilter may lead to a chlorine depletion. This, in turn, may result in falsified measuring values.**

#### 7.1.2 DPD1 Measuring – free chlorine calibration

According to the nationally applicable provisions (such as DIN, ÖNORM, Sia, ...), a manual measurement of the free chlorine must be conducted at regular intervals and the result must be documented in the operating log. The determination of the free chlorine is done by means of the DPD1 method. For this measurement, various photometric measuring procedures are available. If a major deviation is detected between the display and the determined free chlorine measurement, a DPD1 calibration must be carried out.

## 7.1.3 pH measurement – calibrate pH electrode

Each pH electrode is a wear part. It is subject to a certain degree of ageing, which is due to a variety of factors. In the area of swimming pool water treatment, a life span of 6 months to 2 years may be expected.

The contamination of the electrode may be one reason for measuring value deviations. These contaminations can usually be removed by means of the included electrode cleaner. For this purpose, the glass shaft of the pH electrode is submerged in the electrode cleaner for a few minutes.

Depending on the state and age of the electrode, the electrode's characteristics may change. This leads to measuring value deviations that can be compensated by means of a calibration.



### **ATTENTION !**

**During all work on the pH electrode it must be ensured that neither the electrode's screw plug head nor the plug of the electrode cable are exposed to moisture! Even the smallest amount of moisture in the electrode head may lead to a falsification of the measuring value or even to a premature failure of the electrode!**

**All contacts in the electrode's plug head and on the electrode plug must display a shiny golden colour and may not show any signs of corrosion.**



### **NOTICE !**

**After each cleaning or exchange of the electrode, a calibration must be carried out! Do not touch the glass top (sensor part) and the diaphragm with your fingers. Dab the glass top with a clean and soft cloth.**

## 7.1.4 Combination reference-return electrode

For the combination reference-return electrode (PG13,5 blue), a service life of one to two years may be expected, as well. The same safety measures as for the pH electrode apply.



### **NOTICE !**

**After each cleaning or exchange of the electrode, a calibration must be carried out! Do not touch the glass top (sensor part) and the diaphragm with your fingers. Dab the glass top with a clean and soft cloth.**

## 7.1.5 Chlorine electrode - exchange the gasket set

As part of the annual maintenance, the flat gasket in the chlorine electrode  $\frac{3}{4}$ " and the corresponding O ring in the measuring cell must be exchanged.



## 7.1.6 Redox electrode - exchange the gasket set

As part of the annual maintenance, the flat gasket in the redox electrode ½“ and the corresponding O ring in the measuring cell must be exchanged.

## 7.1.7 Flow regulator - exchange the maintenance set

The membrane in the flow control valve tends to age and become brittle. This results in an inadequate flow regulation at different operation states. A maintenance set with the required components is available.

## 7.1.8 Open and close the casing



### **DANGER !**

**Risk of death due to high voltage. All electrical work on the device may only be conducted by properly trained specialists under compliance with the applicable safety regulations!**

**Fuses in the interior of the control casing may only be exchanged by maintenance or repair personnel.**

For type GR 10-CPR and 2S

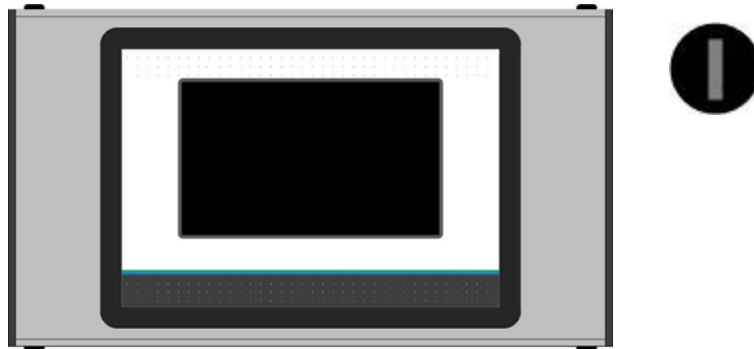

Figure 8, control casing, type GR 10-CPR and 2S

Depending on the type of device, the display lid can be swivelled to the left or right for installation and maintenance work. The locking axle must be removed for swivelling. The locking axle is identified by the plastic slotted screws on both sides. The other side is equipped with two expanding rivets as pivot bearings.



### **Tip !**

**It is not necessary to completely remove the display lid for maintenance tasks! Only the locking axle must be removed. Afterwards, the display can be swivelled to the side.**

For type GR 45/100-CPR

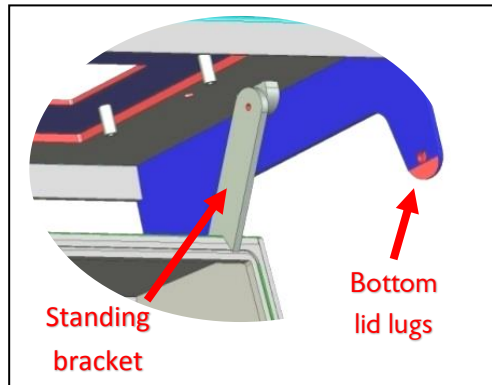

The casing is equipped with an *easy latch lock*. To open the display lid or the small connection compartment lid, gently lift the lateral lid lugs from the base casing toward the outside. Then you can pull the display lid toward the front. In this process, the upper lid lugs run in guiding grooves to the anterior resting point.

Afterwards, the display lid is raised. A support bracket allows to prop up the display lid on the base casing, thus keeping it in an open position for terminal work.

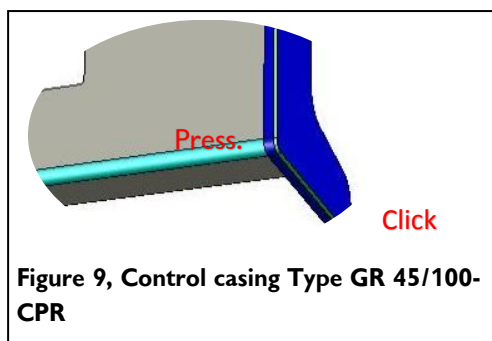

To close the casing again, release the support bracket toward the rear and lower the lid. Then unlock the upper lid lugs and push the lid backwards onto the base casing. In order to tightly seal the casing, exert light pressure on the four corners of the casing.

**Figure 9, Control casing Type GR 45/100-CPR**

The casing lid will close with a soft, audible click.

Please ensure that all lid lugs are always locked with the safety bolt.

## 7.2 Regular water check

The components of the measuring device are subject to a natural ageing process. This can lead to the falsification of the displayed measuring values. To ensure a problem- and disruption-free operation of the system, a regular water check and calibration of the measuring device is urgently required (see *maintenance protocol under Section 9.5*). Please observe the country-specific provisions in this regard!







The pH value in the buffer tank must be checked every 2 months. (optional)











## 7.3 Disruption removal









### Tip !

**All disruptions and messages are displayed on the touch screen in the IN list. In addition, they may be queries in the Event Log. It is also possible that switches or sensors are faulty and thus do not transmit any electric signals. An error will only be displayed once it has occurred uninterrupted for at least 6 seconds.**

Fault display	Effect	Cause / measures
<b>1.  Disinfectant empty ALARM:</b> Chlorine tank empty	This notification serves for information purposes only, no action ensues. The disinfectant dosing and the motive water pump continue to run.	1. Refill disinfectant, or replace container 2. If the disinfectant is not empty, recalibrate the empty switch or 3. renew the empty switch.
<b>2.  Acid empty ALARM:</b> Acid container empty	The acid dosing stops and the motive water pump continues to run.	1. replace the empty acid container with a full one 2. If the acid container is not empty, the empty switch is defective. 3. In the event of a new suction lance, check the functional direction of the float.
<b>3.  Flocculation empty ALARM:</b> Flocculant container empty	The flocculant dosing stops and the motive water pump continues to run.	1. replace the empty flocculant container with a full one 2. If the flocculant container is not empty, the empty switch is defective. 3. In the event of a new suction lance, check the functional direction of the float
<b>4.  Pressure minimal ALARM:</b> The flowpressure for the motive water pump is too low.	The dosing is stopped. The motive water pump has been switched off.	1. Supply pressure too low 2. Motive water pump faulty 3. Pressure switch faulty 4. Set a lower response pressure at the pressure switch
<b>5.  Level flushing tank minimal ALARM:</b> The water level in the flushing tank is too low; more water is suctioned off than runs into the flushing tank through the float valve.	The dosing is stopped. The motive water pump has been switched off.	1. Float valve function: <ol style="list-style-type: none"> <li>The water inflow should gently follow the float's movement. When OK, calibrate the water level. See OI Dosing unit, section Commissioning</li> <li>If this is not the case, insert a new membrane in the float valve.</li> </ol> 2. Insert a pinhole aperture with a small drill hole 3. Prefilter (Pos. 9) dirty → clean
<b>6.  Level flushing tank maximal ALARM:</b> The water level in the flushing tank is too high; less water is suctioned off than runs into the flushing tank through the float valve.	The dosing is stopped. The motive water pump continues to run.	1. If the injector's suction performance is OK: <ol style="list-style-type: none"> <li>Float valve function: The water inflow should gently follow the float's movement. When OK, calibrate the water level. See OI Dosing unit, section Commissioning</li> <li>If this is not the case, insert a new membrane in the float valve.</li> </ol> 2. If the suction performance is insufficient, see under fault display " <b>Flow rate suction pipe minimal ALARM</b> "

<p><b>7.  Flow rate suction pipe minimal ALARM:</b> The water flow in the suction pipe is to low. The switch body of the flow switch does not rise, the switch LED is illuminated.</p>	<p>The dosing is stopped. The motive water pump continues to run.</p>	<ol style="list-style-type: none"> <li>1. Check the function of the motive water pump.</li> <li>2. Prefilter dirty → clean (GR only)</li> <li>3. Blocked suction opening in the flushing tank</li> <li>4. It is possible that particles are present in the injector and/or in the suction pipe, due to particles released during assembly or from the chlorine</li> <li>5. Insert a pinhole aperture with a larger drill hole or remove it entirely</li> <li>6. Blocked check valve at the buffer tank</li> <li>7. Worn diffusor; if D &gt; 6.5mm, replace diffusor</li> </ol>
<p><b>8.  Dosing monitoring chlorine in cyclone ALARM:</b> The optical sensor at the cyclone responds.</p>	<p>The Sensor at the cyclone indicates that an insufficient amount of chlorine is in the cyclone during the 2nd dosing interval</p>	<ol style="list-style-type: none"> <li>1. Disruption during dosing:             <ol style="list-style-type: none"> <li>a) Clotting in the chlorine granulate</li> <li>b) Dosing screw blocked due to poor chlorine quality (too fine, moist)</li> </ol> </li> <li>2. The dosing motor is defective.</li> <li>3. Calibrate the optical sensor</li> </ol>
<p><b>9.  Fuse chlorine dosing motor ALARM:</b></p>	<p>The chlorine dosing stops and the motive water pump continues to run.</p>	<p>Check chlorine motor for blockage, remove blockage and replace fuse, if applicable.</p>
<p><b>10.  Buffer tank filling start NOTIFICATION:</b></p>	<p>The filling starts</p>	<p>The dosing device starts to generate the chlorine solution</p>
<p><b>11.  Buffer tank filling stop NOTIFICATION:</b></p>	<p>The filling stops</p>	<p>The rinse cycle starts; afterwards, the dosing device stops generating the chlorine solution</p>
<p><b>12.  Level buffer tank minimal ALARM:</b></p>	<p>The lower control switch for starting the filling has not triggered.</p>	<p>Check switch function: If the tank is empty, the switch contact must be closed (measure at the terminal). If open: Switch or terminal contact faulty</p>
<p><b>13.  Level buffer tank maximal ALARM:</b></p> <p>or</p> <p><b>Alarm collecting basin</b></p>	<p>During the filling, the upper control switch Level maximal for the stopping of the filling has not triggered.</p> <p>The level switch in the collecting basin reports fluid in the collecting basin</p>	<ol style="list-style-type: none"> <li>1. Check “Level Buffer tank filling stop”: If the tank is full, the switch contact of the “Level Buffer tank filling stop”-switch must be closed (measure at the terminal). If the switch contact is open when the buffer tank is full, the switch or the terminal contact is defective.</li> <li>2. Level switch “Level Buffer tank filling stop” is OK: → Check the function of the switching valves</li> </ol> <ol style="list-style-type: none"> <li>1. Buffer tank is overflowing or leaks             <ol style="list-style-type: none"> <li>a) Level switches “Level Buffer tank filling stop” and Level maximal alarm at the buffer tank defective. → Replace level switches</li> <li>b) Leaking check valve at a dosing pump → replace check valve</li> <li>c) Leaking buffer tank → replace buffer tank</li> </ol> </li> <li>2. Control valve to the buffer tank does not close</li> </ol>
<p><b>14.  Timeout buffer tank filling ALARM:</b></p>	<p>The puffer tank filling was aborted by the system. The filling was too slow.</p>	<ol style="list-style-type: none"> <li>1. Check the switching valves.</li> <li>2. Check the sensor "buffer tank Start": This contact has to be opened again 3 minutes after the start of the filling!</li> </ol>
<p><b>15.  Flow measuring cell ALARM:</b></p>	<p>The flow through the measuring cell is too low. The dosing stops.</p>	<p>Increase the flow rate on the flow control valve (Pos. 6).</p>
<p><b>16.  Pure water external ALARM:</b></p>	<p>External flow sensor signals to low flow. The dosing and the booster pump stops.</p>	<p>Check pool circulation; If this is okay, then check the flow sensor.</p>

<b>17.  Flocculation leakage ALARM:</b>	On the flocculant dosing pump the hose rupture sensor has triggered. The flocculation dosing stops.	Check the dosing hose of the pump and replace if necessary; If this is OK, so check the dosing valve.
<b>18.  Acid leakage ALARM:</b>	On the acid dosing pump, the hose rupture sensor has triggered. The acid dosing stops.	Check the dosing hose of the pump and replace if necessary: If this is OK, so check the dosing valve.
<b>19.  Disinfection leakage ALARM: (only for type 2S)</b>	On the disinfection dosing pump, the hose rupture sensor has triggered. The disinfection dosing stops.	Check the dosing hose of the pump and replace if necessary: If this is OK, so check the dosing valve.
<b>20.  External OFF NOTIFICATION:</b>	The control unit is disabled by the central control system. There is no dosing, no pool water heating, no alarm message. The dosing device stops.	No action, because an external shutdown occurred.
<b>21.  Dosing time monitoring ALARM:</b>	A dynamic dosing time has been exceeded. The respective output is blocked. To save space, no differentiation is made between the individual channels!	Check dosing screw and dosing pumps for damage and blockage. Eliminate defect or blockage. (see also section 7 to relevant Dosing unit). Check the setting of the dosing capacity, whether this is too low.
<b>22.  Shock chlorination active NOTIFICATION:</b>	The shock chlorination / filter disinfection is active.	No action
<b>23.  ECO operation NOTIFICATION:</b>	The request for "ECO operation" from the central control cabinet is pending	No action

## **Malfunction without display in the device:**

### **1. The display is dark and the device is turned off:**

- a) No supply voltage: → Restore the supply voltage
- b) The main fuse at the lower left of the casing has blown: → Replace fuse
- c) The fuse F1 at the power supply unit has blown: → Replace fuse
- d) The power supply unit is defective: → Replace power supply unit

### **2. The flushing tank overflows when shutting down the GRANUDOS:**

**In this case, one of the following elements is leaking:**

- a) Float valve: → Replace membrane
- b) Switch body in the suction pipe: → Replace gasket
- c) Pressure retention valve at the motive water pump is leaking or adjusted incorrectly: → Replace membrane and adjust pressure retention valve

For the procedure, see operating instructions Part 1 Dosing technology, under Section 7.1, Device maintenance.

## 8 Decommissioning - storage - disposal

### 8.1 General

---

In the event of decommissioning or risk of frost, the devices must be emptied completely and protected against frost!

### 8.2 Decommissioning

---

If the device is decommissioned for an extended period of time (more than approx. 14 days), the following tasks must be conducted.

Depending on the device version, different measures are required for decommissioning. The following tasks relate exclusively to the measuring and control technology.

For required work on the dosing devices, please consult the corresponding device manuals.

- The diaphragm of the combination electrode (electrode with glass shaft) must never dry out. The longest service life for electrodes when not in use can be reached if the glass shaft is stored in the electrolyte. For this, fill the protective cap about halfway with electrolyte and push it on the glass shaft of the pH electrode or the combination reference-return electrode, respectively.
- The combination electrodes are frost-resistant to approx.  $-15^{\circ}\text{C}$ ; if the temperature falls below this value, the electrodes must be stored in a frost-safe environment.
- If condensation moisture can be expected at the installation site, the device must be supplied with continuous voltage in order to protect the electronics. Alternatively, the device may be dismantled and stored in a dry location.
- If frost can be expected at the installation site, all water-bearing parts, such as the measuring water pipes and the measuring cell, must be emptied completely.

### 8.3 Disposal of used parts and operating materials

---



Dismounted, contaminated parts must be thoroughly cleaned and then disposed of according to the regulations applicable at the site of operation or they must be recycled. For the operating materials, observe the corresponding packaging notices. In case of doubt, information is available at your local institution responsible for disposal.

If this is not possible, dispose the components/materials as hazardous waste.

## 9 Documents

### 9.1 Declaration of conformity

---

See operating instructions Part 1 regarding the respective dosing device.

### 9.2 Terminal diagrams

---



#### **DANGER !**

**Risk of death due to high voltage. All electrical work on the device may only be conducted by properly trained specialists under compliance with the applicable safety regulations! Internal fuses may only be replaced with interrupted voltage that is protected against reactivation!**

## 9.2.1 Terminal diagram power supply unit for device 2S



### **DANGER!**

**Risk of death due to high voltage. All electrical work on the device may only be conducted by properly trained specialists under compliance with the applicable safety regulations! Internal fuses may only be replaced with interrupted voltage that is protected against reactivation!**

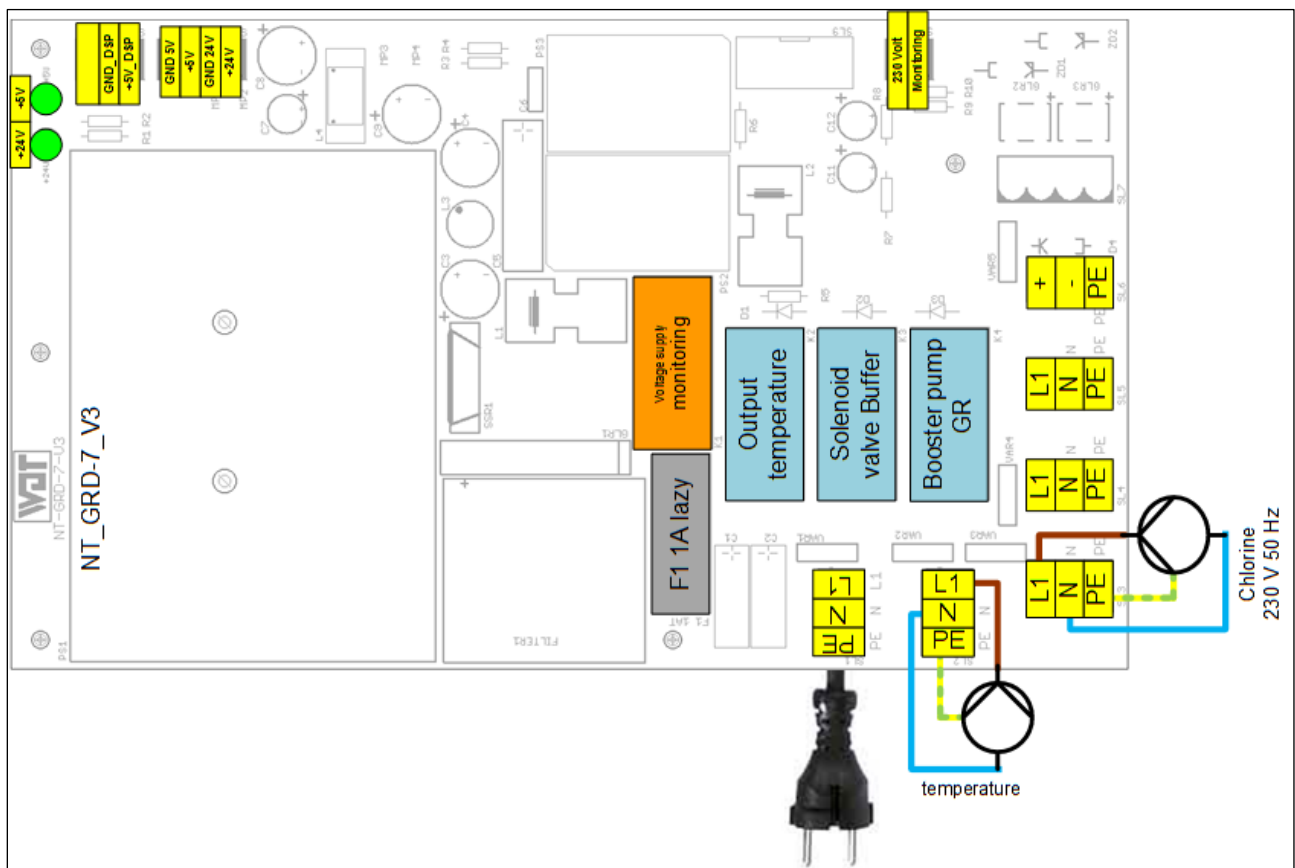

The figure shows the connection of a 230 volt circulation pump for the heating of the basin water and the chlorine output 230 V 50 Hz as an example.

Fuses	Current	Fuse type	Function
F1	1.0A slow	5 x 20mm	Supply of the switching power supplies on the power supply's circuit board;



## 9.2.2 Terminal diagram I/O Board for device 2S

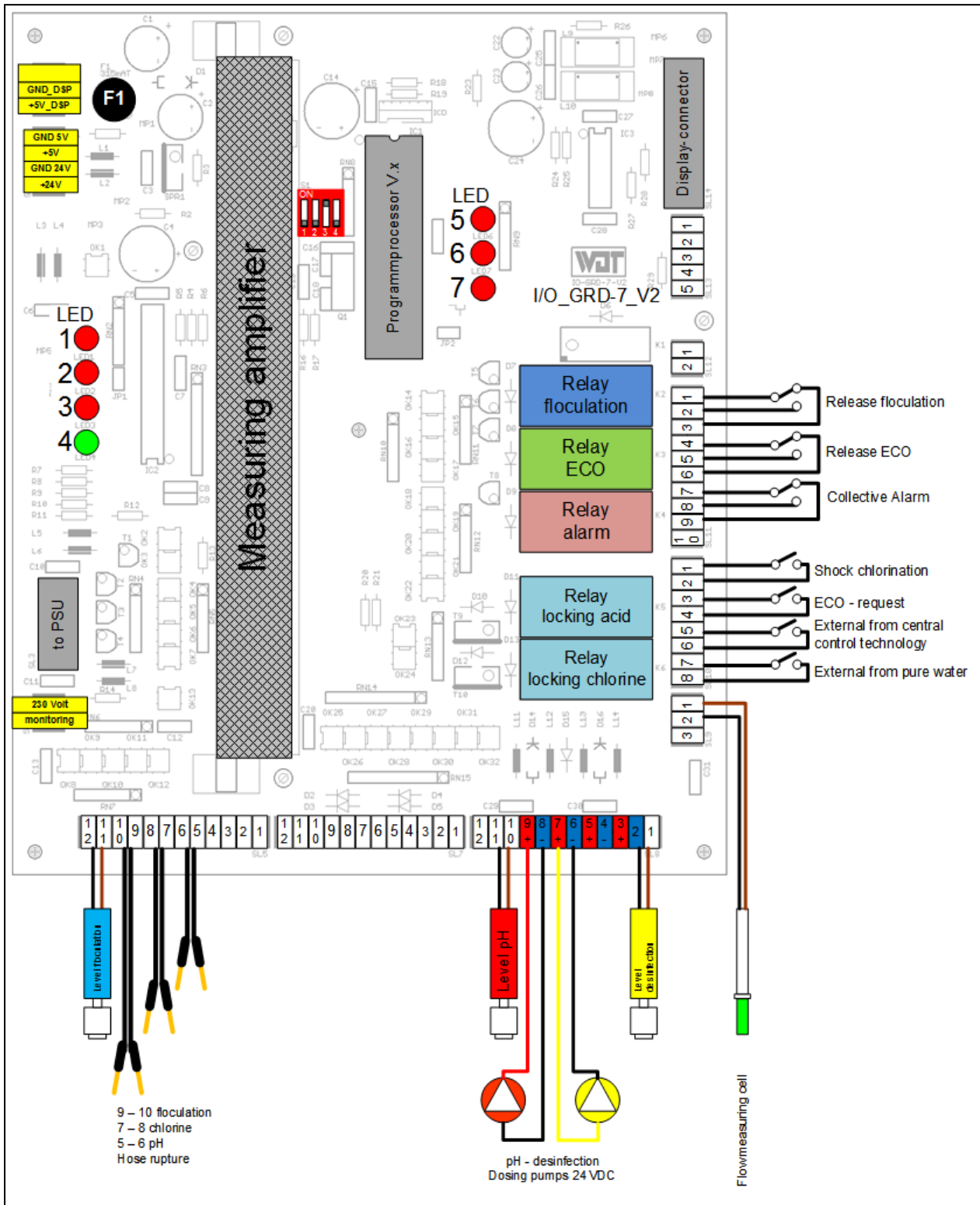

The figure shows the connected sensors or consumers, respectively, of the device version 2S (with two hose pumps).

Fuses	Current	Fuse type	Function
F1	315mA slow	Micro-fuse	Output disinfection 24V, SL08

## 9.2.3 Terminal diagram I/O Board for external dosing unit

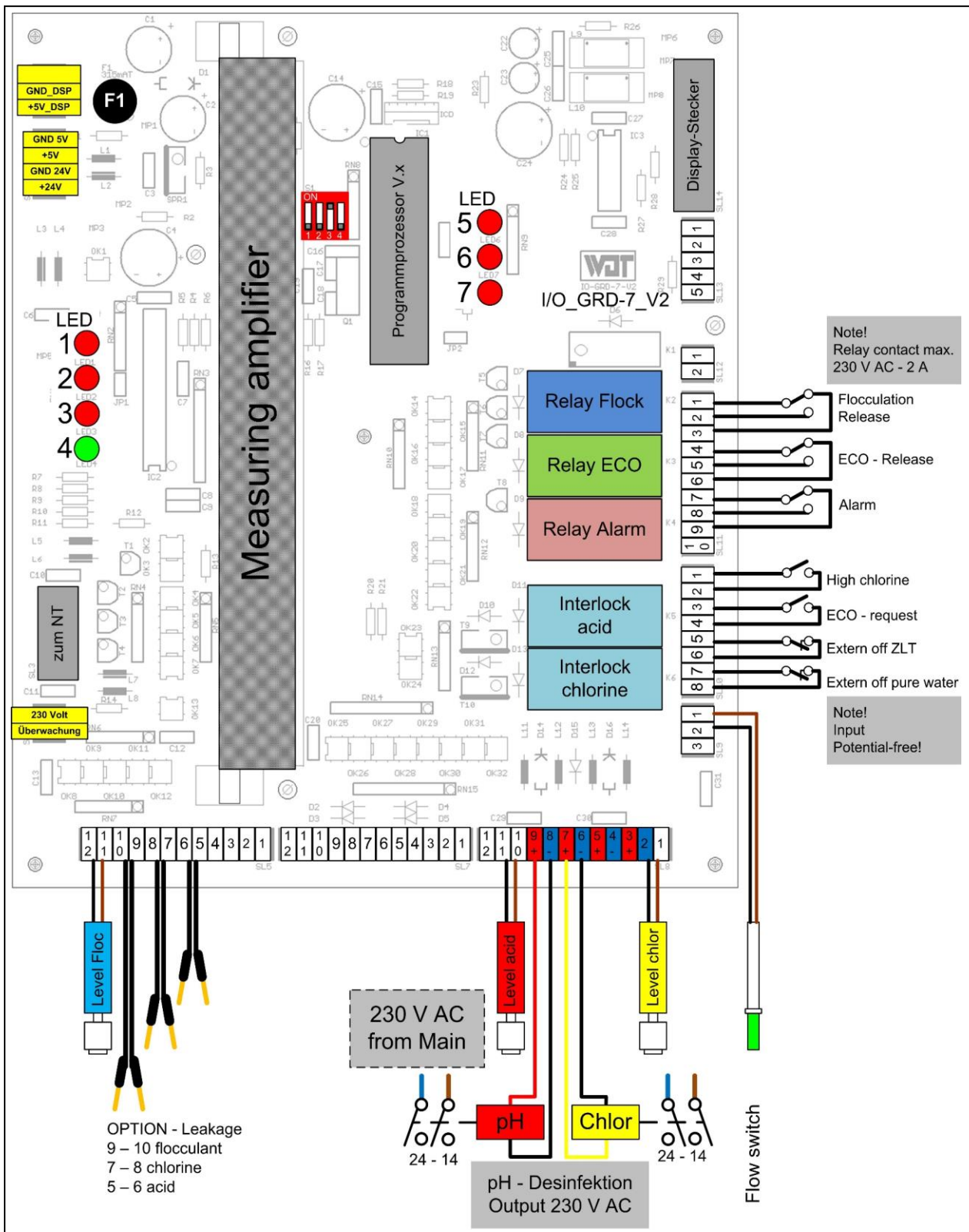

The figure shows the connected sensors or consumers, respectively, of the device version 2S (with two relays).

Fuses	Current	Fuse type	Function
F1	315mA slow	Micro-fuse	Output disinfection 24V, SL08

## 9.2.4 The measuring amplifier

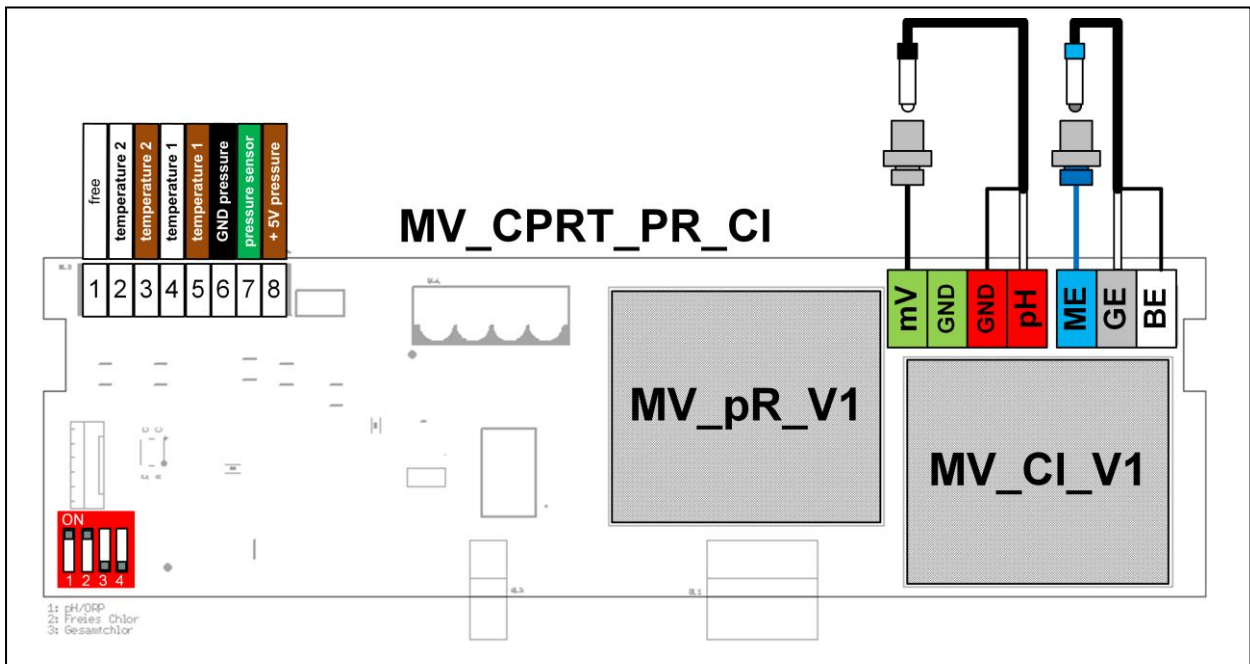

The measuring amplifier is constructed of several circuit boards.

### MV CPRT PR CI

The basic circuit board MV\_CPRT\_V1.1 contains the measuring transformer for temperature and pressure measurements. It also serves to accommodate the two measuring transformers MV\_pR and MV\_CI.

- 1 = free
- 2 + 3 = Temperature sensor 2 Pt1000 (OPTION not available for all device variants)
- 4 + 5 = Temperature sensor 1 Pt1000
- 6,7,8 = Pressure switch (OPTION not available for all device variants)

### MV pR V1

The circuit board MV\_pR\_V1 contains the measuring transformer for pH and redox measurements.

- mV = Redox electrode (black line to redox electrode) → Platinum round blank
- GND = Mass (shielding of the coaxial line mV - OPTION)
- GND = Mass (shielding of the coaxial line pH)
- pH = pH electrode (internal conductor of the coaxial line)

### MV CI V1

The circuit board MV\_CI\_V1 contains the measuring transformer for the free chlorine measurements.

- ME = Measuring electrode chlorine (blue line to the gold electrode) → Gold round blank
- GE = Return electrode (internal conductor of the coaxial line) → Metal sensor of the combination electrode
- BE = Reference electrode (shielding of the coaxial line) → Reference system of the combination electrode

## 9.2.5 Terminal diagram power supply with connection to the IO circuit board for device GR 10-CPR

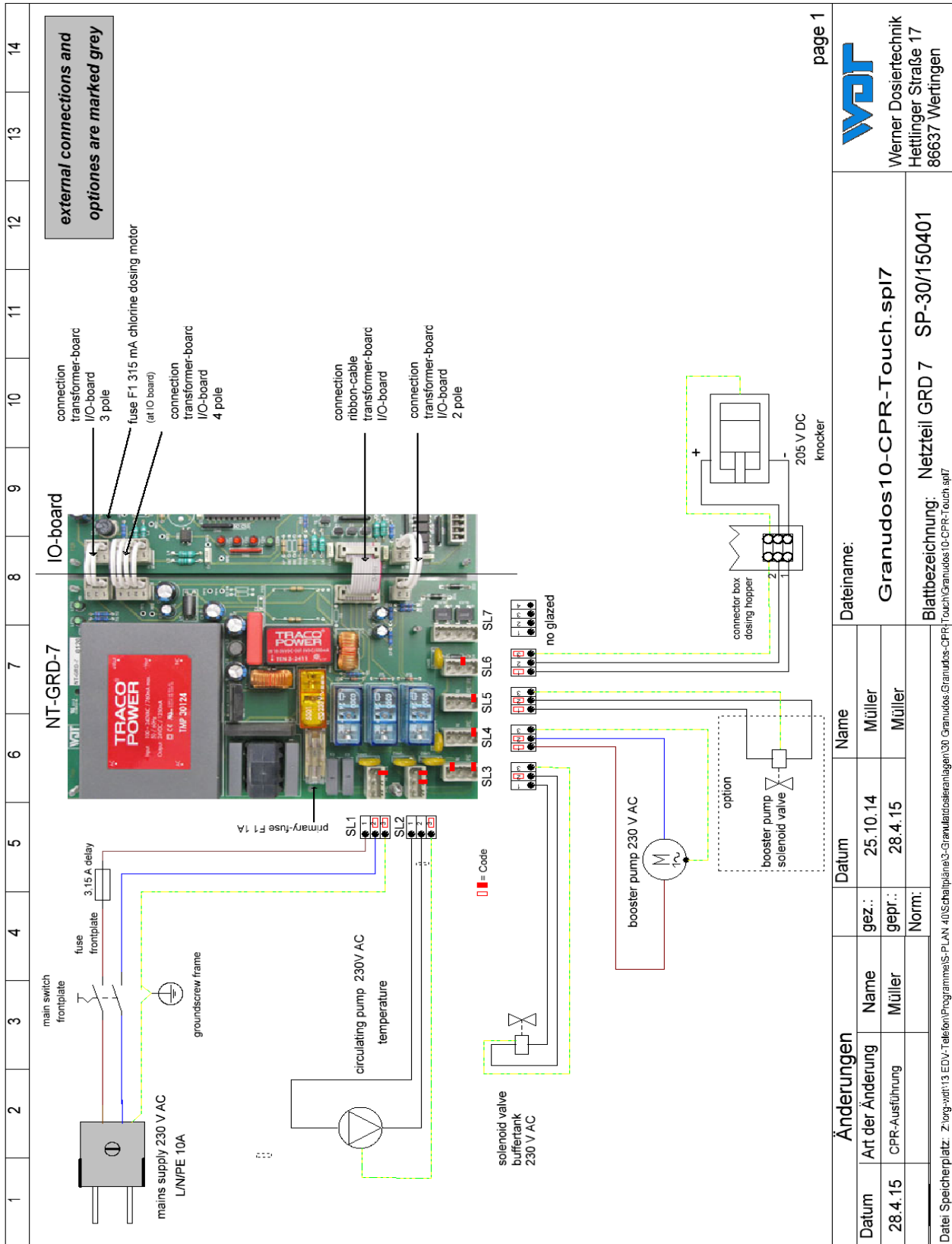

Fuses	Current	Fuse type	Function
F0	3.15A slow	5 x 20mm	Main fuse control casing
F1	1.0A slow	5 x 20mm	Primary fuse

## 9.2.6 Terminal diagram I/O circuit board GRD 7 for device GR 10-CPR

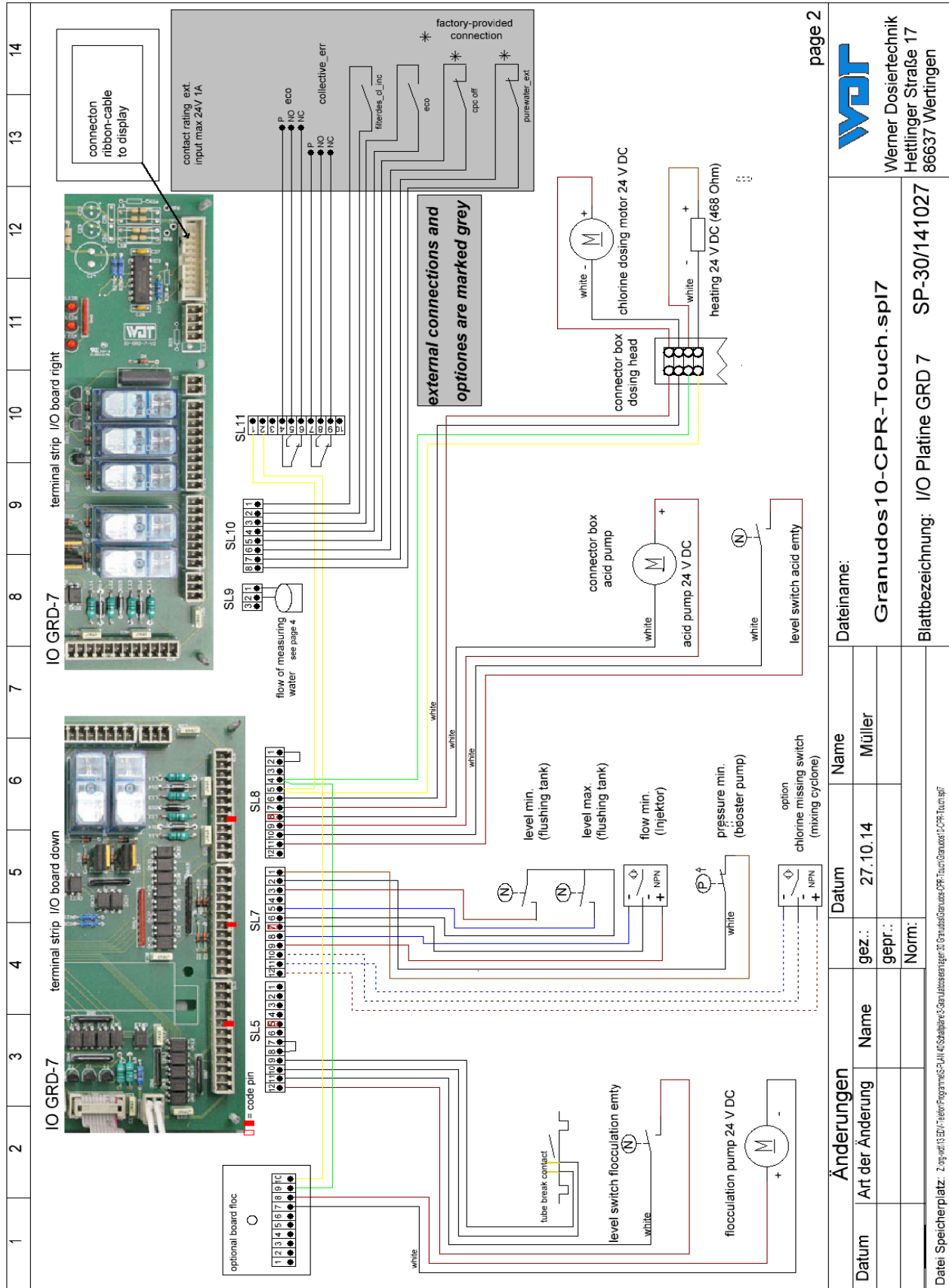

page 2

**WDT**  
Werner Dosiertechnik  
Hettinger Straße 17  
86637 Wertingen

Dateiname:  
**Granudos10-CPR-Touch.sp17**  
Blattbezeichnung: I/O Platine GRD 7 SP-30/141027

Änderungen		Datum	Name
Datum	gez.:	27.10.14	Müller
Art der Änderung	gepr.:		
	Norm:		

Datei Speicherplatz: Z:\proj\13.01\13.01\Proj\Fregma\5-Granudos10-CPR-Touch.sp17

## 9.2.7 Terminal diagram power supply with connection to the I/O circuit board for device GR 45/100-CPR

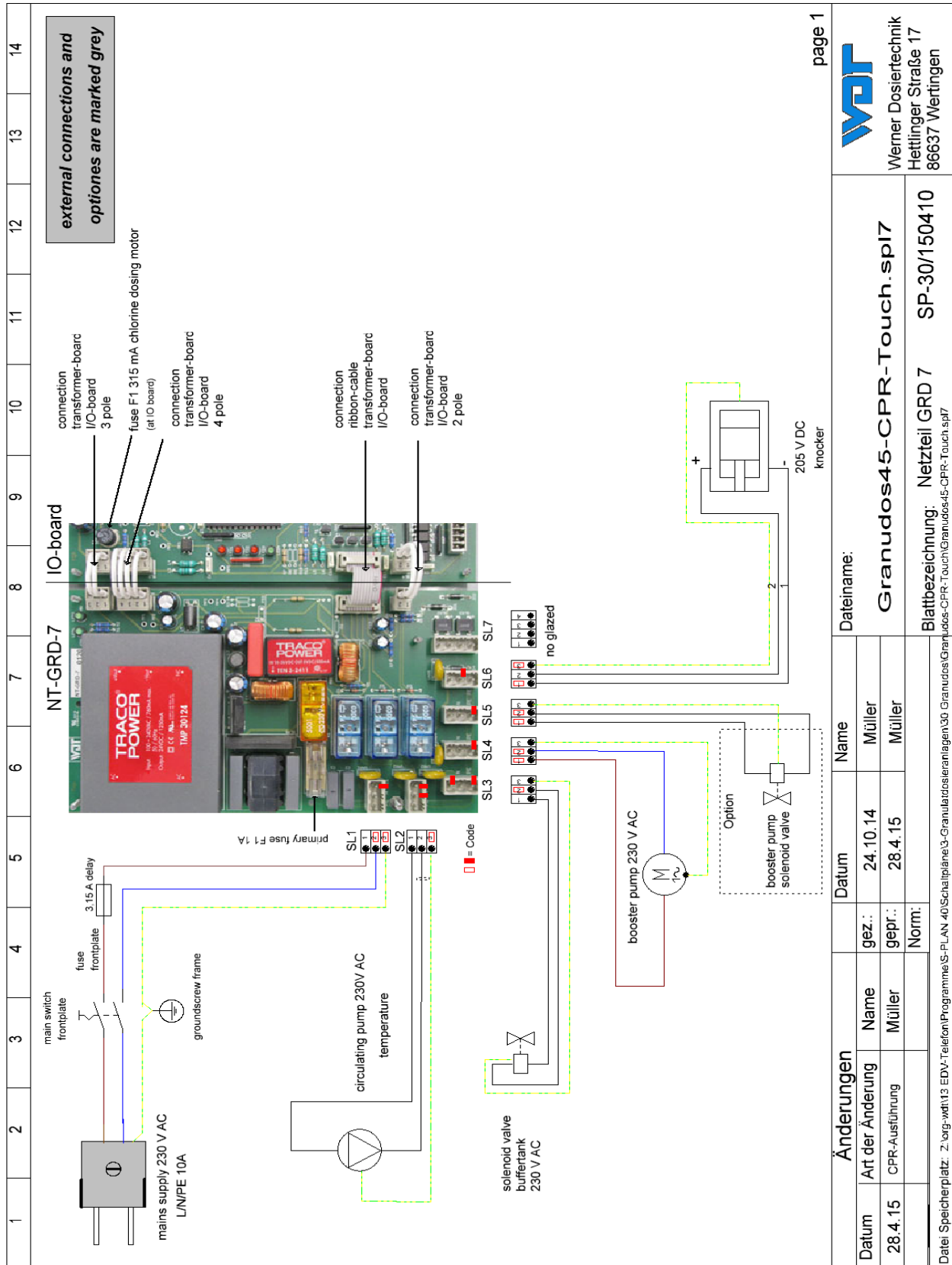

page 1



Werner Dosiertechnik  
Hettlinger Straße 17  
86637 Wertingen

Dateiname:

Granudos45-CPR-Touch.sp17

Blattbezeichnung: Netzteil GRD 7 SP-30/150410

### Änderungen

Datum	Art der Änderung	Name	Datum	Name
28.4.15	CPR-Ausführung	Müller	24.10.14	Müller
			28.4.15	Müller
			Norm:	

Datei Speicherplatz: Z:\org-wdt\13 EDV-Teile\Programme\PLAN 40\Schaltpläne\3-Granulatdosieranlagen\30\_Granudos-CPR-Touch\Granudos-45-CPR-Touch.sp17

Fuses	Current	Fuse type	Function
F0	3.15A slow	5 x 20mm	Main fuse front panel
F1	1.0A slow	5 x 20mm	Primary fuse

## 9.2.8 Terminal diagram I/O circuit board GRD 7 for device GR 45/100-CPR

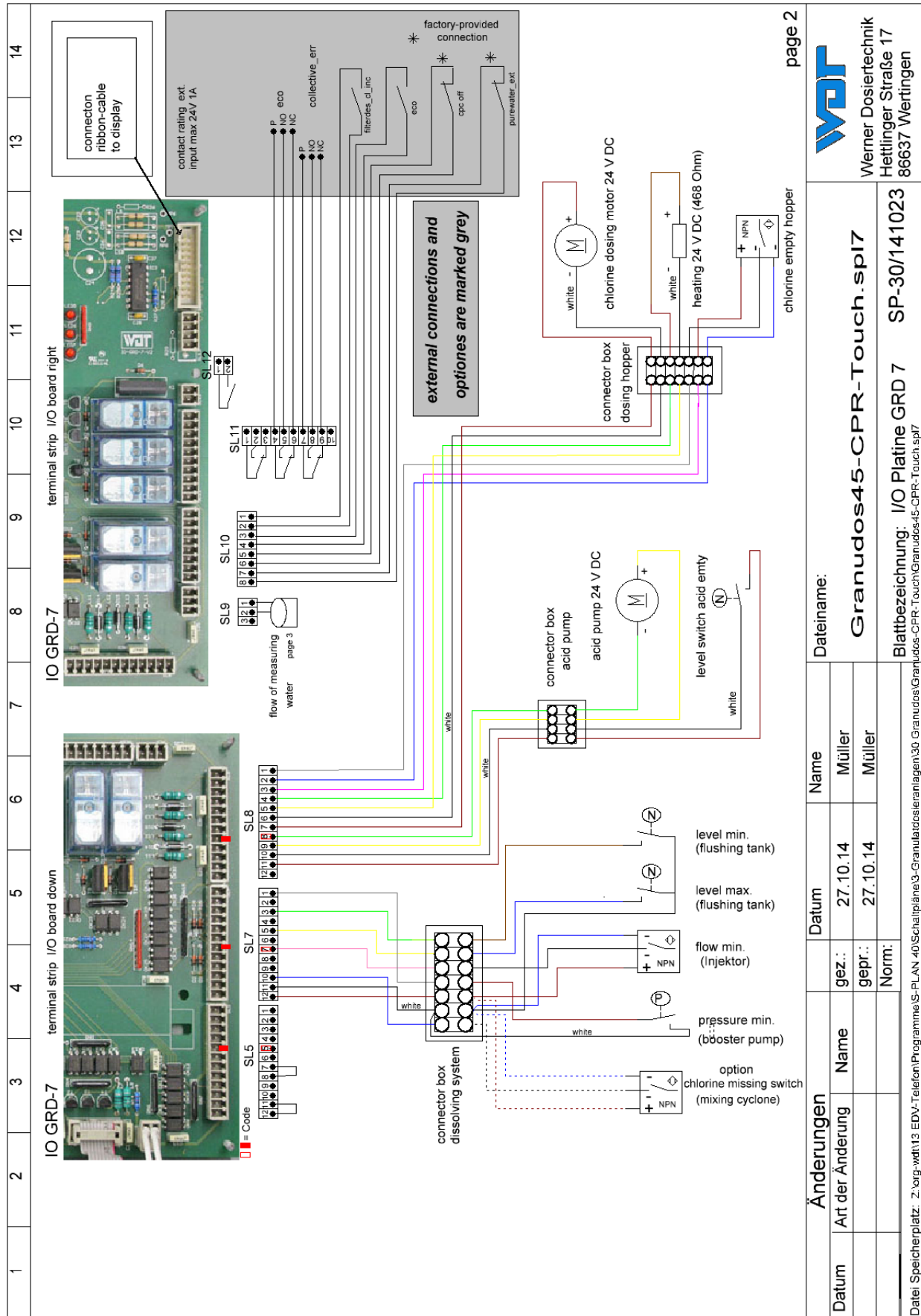

page 2



Werner Dosierttechnik  
Hettinger Straße 17  
86637 Wertingen

Dateiname:

Granudos45-CPR-Touch.sp17

Blattbezeichnung: I/O Platine GRD 7 SP-30/141023  
Datei Speicherplatz: Z:\org-wdt\13 EDV-Telefon\Programme\S-PLAN\_40\Schaltpläne\3-Granulatdosieranlagen\30\_Granudos\Granudos45-CPR-Touch.sp17

Änderungen		Datum	Name
Datum	Art der Änderung	gez.: 27.10.14	Müller
		gepr.: 27.10.14	Müller
		Norm:	

## 9.2.9 Terminal diagram buffer tank GRD 7 for the devices GR 10-CPR and GR 45/100-CPR

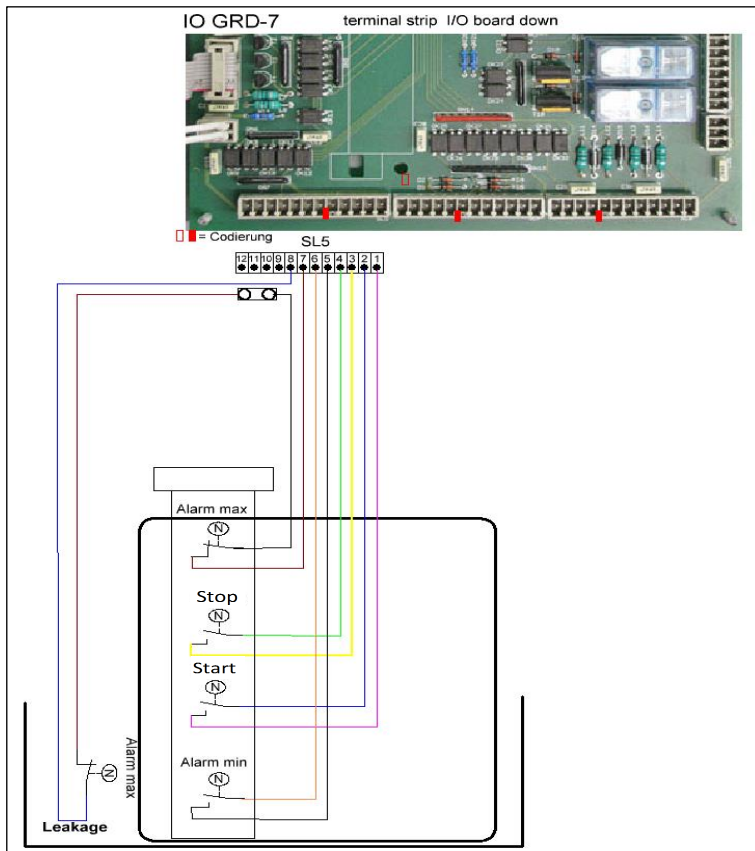

## 9.2.10 Terminal diagram measuring plate for the devices GR 10-CPR and GR 45/100-CPR

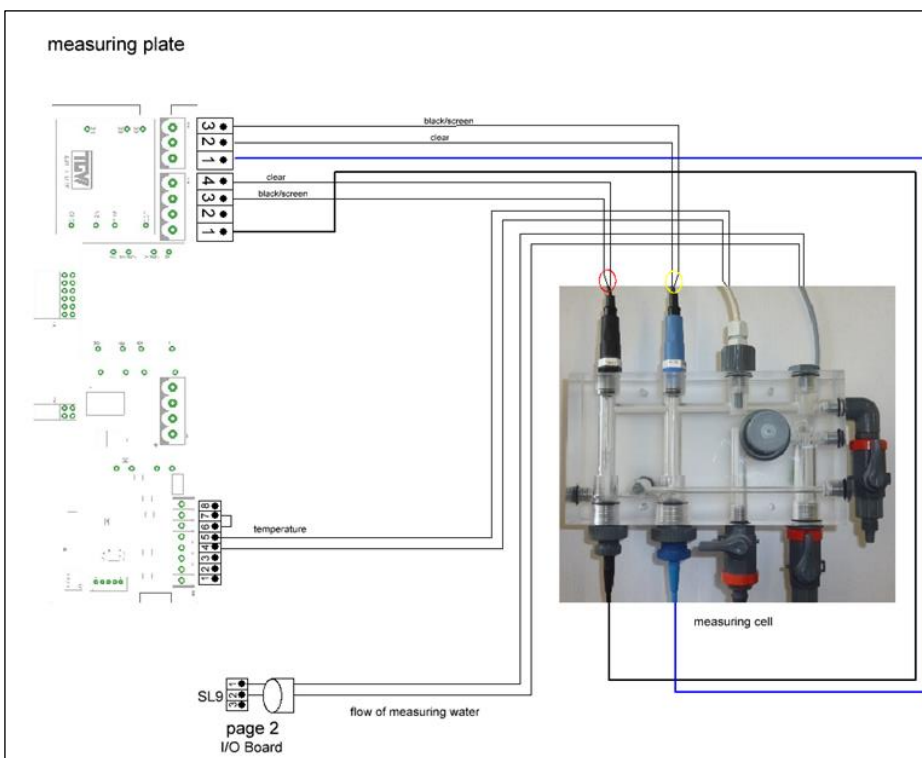



---

## 9.3 Commissioning protocol

---

See operating instructions Part 1 Dosing system, regarding the respective dosing device.

## 9.4 Operation data sheet



During a “firmware update,” all parameters are reset to the factory setting. After an “update,” all parameters must therefore be checked and readjusted to the basin. We therefore recommend that you enter the optimised, basin-specific parameters in this list. In addition, the electrodes must be calibrated after an “firmware update!”

Settings menu	Factory setting	Setting ranges	Step	during commissioning	Optimised during operation
<b>1 Parameter chlorine</b>				Date:	Date:
- Range	0-2	0-2 or 0-8			
- Setpoint	0.6mg/l	0.1 – 2.0/8.0	0.05		
- P-range	0.3	0.05 – 2.00	0.05		
- Alarm low	0.2	off – 2.00	0.05		
- Alarm high	0.8	0.1 – 2.0/8.0/off	0.05		
<b>2 Dosing performance</b>					
- pH	100% = 8 sec.	1.04 – 100%			
- Disinfection	100% = 15 sec.	0.55 – 100%			
- Cycle time	30 Sec.	30 – 360 sec.	30		
Manual dosing	Off	Off – On			
<b>3 Parameter mV - Redox</b>					
- Alarm low	600mV	400 – 900mV	10		
- Alarm high	800mV	500 – 990mV	10		
Regulation	Off	Off - On			
<b>4 Parameter mV - Redox</b>	<b>Redox control Emergency operation</b>				
- Setpoint	750mV	500 – 900mV	5		
- P-range	100mV	10 – 100	10		
- Alarm low	600mV	400 – 900mV	10		
- Alarm high	800mV	500 – 990mV	10		
- Dosing time limit	30 minutes	off – 60 min	2		
<b>5 Parameter Temperature</b>					
- Setpoint	25 °C	15 – 40°C	0.1		
- P-range	1 K	1 – 10K	0.1		
- Alarm low	10 °C	5 – 50°C	0.1		
- Alarm high	30 °C	15 – 55°C	0.1		
- Offset	0 °C	-5°C - +5°C	0.1		
Regulation	Off	Off - On			
<b>6 Dosing delay</b>					
- Dosing delay	600 seconds	10 - 600 seconds	10		
<b>7 Flocculation</b>					
- Off – On	On	Off - On			
<b>8 ECO operation</b>					
- Range	0-2	0-2 or 0-8			
- Setpoint	0.6mg/l	0.1 – 2.0/8.0	0.05		
- P-range	0.3	0.05 – 2.00	0.05		
- Alarm low	0.2	off – 2.00	0.05		
- Alarm high	0.8	0.1 – 2.0/8.0/off	0.05		
- Dosing time limit	30 minutes	off – 60 min	2		
<b>Param. mV – Redox ECO</b>					
- Level value	750mV	500 – 900mV	5		
- Alarm low	600mV	400 – 900mV	10		
- Alarm high	800mV	500 – 990mV	10		

<b>Parameter times ECO</b>			
Monday	--:--	00:00 -> 24:00	
Monday	--:--	00:00 -> 24:00	
Monday	--:--	00:00 -> 24:00	
Monday	--:--	00:00 -> 24:00	
Tuesday	--:--	00:00 -> 24:00	
Tuesday	--:--	00:00 -> 24:00	
Tuesday	--:--	00:00 -> 24:00	
Tuesday	--:--	00:00 -> 24:00	
Wednesday	--:--	00:00 -> 24:00	
Wednesday	--:--	00:00 -> 24:00	
Wednesday	--:--	00:00 -> 24:00	
Wednesday	--:--	00:00 -> 24:00	
Thursday	--:--	00:00 -> 24:00	
Thursday	--:--	00:00 -> 24:00	
Thursday	--:--	00:00 -> 24:00	
Thursday	--:--	00:00 -> 24:00	
Friday	--:--	00:00 -> 24:00	
Friday	--:--	00:00 -> 24:00	
Friday	--:--	00:00 -> 24:00	
Friday	--:--	00:00 -> 24:00	
Saturday	--:--	00:00 -> 24:00	
Saturday	--:--	00:00 -> 24:00	
Saturday	--:--	00:00 -> 24:00	
Saturday	--:--	00:00 -> 24:00	
Sunday	--:--	00:00 -> 24:00	
Sunday	--:--	00:00 -> 24:00	
Sunday	--:--	00:00 -> 24:00	
Sunday	--:--	00:00 -> 24:00	
<b>9 System → Password</b>			
End user	—	0000 – 9999	1
Technician 1	01234	00000 – 99999	1
<b>10 System → Display</b>			
Screensaver	20%	12 - 100%	2
Delay	00:05	00:00 – 23:59	
Backlight	75%	24 - 100%	2
<b>11 System → Network</b>			
IP address	192.168.0.1		
Gateway	192.168.0.0		
Subnetmask	255.255.255.0		
<b>12 System → Language</b>			
<b>13 Shock chlorination</b>			
Dosing performance acid	7%	0 - 100%	1
Dosing performance chlorine	50%	50 - 100%	1
<b>14 Buffer tank</b>			
Dosing performance acid	7%	0 - 100%	1
Dosing performance chlorine	50%	50 - 100%	1
Activate buffer tank	Off	Off – On	

Operation data sheet, –master copy–

Please copy the blank operation data sheet before filling it out!

Settings menu	Factory setting	Setting ranges	Step	during commissioning	Optimised during operation
<b>1 Parameter chlorine</b>				Date:	Date:
- Range	0-2	0-2 or 0-8			
- Setpoint	0.6mg/l	0.1 – 2.0/8.0	0.05		
- P-range	0.3	0.05 – 2.00	0.05		
- Alarm low	0.2	off – 2.00	0.05		
- Alarm high	0.8	0.1 – 2.0/8.0/off	0.05		
<b>2 Dosing performance</b>					
- pH	100% = 8 sec.	1.04 – 100%			
- Disinfection	100% = 15 sec.	0.55 – 100%			
- Cycle time	30 seconds	30 – 360 sec.	30		
Manual dosing	Off	Off – On			
<b>3 Parameter mV - Redox</b>					
- Alarm low	600mV	400 – 900mV	10		
- Alarm high	800mV	500 – 990mV	10		
Regulation	Off	Off - On			
<b>4 Parameter mV - Redox</b>	<b>Redox control Emergency operation</b>				
- Setpoint	750mV	500 – 900mV	5		
- P-range	100mV	10 – 100	10		
- Alarm low	600mV	400 – 900mV	10		
- Alarm high	800mV	500 – 990mV	10		
- Dosing time limit	30 minutes	off – 60 min	2		
<b>5 Parameter Temperature</b>					
- Setpoint	25 °C	15 – 40°C	0.1		
- P-range	1 K	1 – 10K	0.1		
- Alarm low	10 °C	5 – 50°C	0.1		
- Alarm high	30 °C	15 – 55°C	0.1		
- Offset	0 °C	-5°C - +5°C	0.1		
Regulation	Off	Off - On			
<b>6 Dosing delay</b>					
- Dosing delay	600 seconds	10 – 600 sec.	10		
<b>7 Flocculation</b>					
- Off – On	On	Off - On			
<b>8 ECO operation</b>					
- Range	0-2	0-2 or 0-8			
- Setpoint	0.6mg/l	0.1 – 2.0/8.0	0.05		
- P-range	0.3	0.05 – 2.00	0.05		
- Alarm low	0.2	off – 2.00	0.05		
- Alarm high	0.8	0.1 – 2.0/8.0/off	0.05		
- Dosing time limit	30 minutes	off – 60 min	2		
<b>Parameter mV - Redox ECO</b>					
- Level value	750mV	500 – 900mV	5		
- Alarm low	600mV	400 – 900mV	10		
- Alarm high	800mV	500 – 990mV	10		

<b>Parameter times ECO</b>			
Monday	--:--	00:00 -> 24:00	
Monday	--:--	00:00 -> 24:00	
Monday	--:--	00:00 -> 24:00	
Monday	--:--	00:00 -> 24:00	
Tuesday	--:--	00:00 -> 24:00	
Tuesday	--:--	00:00 -> 24:00	
Tuesday	--:--	00:00 -> 24:00	
Tuesday	--:--	00:00 -> 24:00	
Wednesday	--:--	00:00 -> 24:00	
Wednesday	--:--	00:00 -> 24:00	
Wednesday	--:--	00:00 -> 24:00	
Wednesday	--:--	00:00 -> 24:00	
Thursday	--:--	00:00 -> 24:00	
Thursday	--:--	00:00 -> 24:00	
Thursday	--:--	00:00 -> 24:00	
Thursday	--:--	00:00 -> 24:00	
Friday	--:--	00:00 -> 24:00	
Friday	--:--	00:00 -> 24:00	
Friday	--:--	00:00 -> 24:00	
Friday	--:--	00:00 -> 24:00	
Saturday	--:--	00:00 -> 24:00	
Saturday	--:--	00:00 -> 24:00	
Saturday	--:--	00:00 -> 24:00	
Saturday	--:--	00:00 -> 24:00	
Sunday	--:--	00:00 -> 24:00	
Sunday	--:--	00:00 -> 24:00	
Sunday	--:--	00:00 -> 24:00	
Sunday	--:--	00:00 -> 24:00	
<b>9 System → Password</b>			
End user	—	0000 – 9999	1
Technician 1	01234	00000 – 99999	1
<b>10 System → Display</b>			
Screensaver	20%	12 - 100%	2
Delay	00:05	00:00 – 23:59	
Backlight	75%	24 - 100%	2
<b>11 System → Network</b>			
IP address	192.168.0.1		
Gateway	192.168.0.0		
Subnetmask	255.255.255.0		
<b>12 System → Language</b>			
<b>13 Shock chlorination</b>			
Dosing performance acid	7%	0 - 100%	1
Dosing performance chlorine	50%	50 - 100%	1
<b>14 Buffer tank</b>			
Dosing performance acid	7%	0 - 100%	1
Dosing performance chlorine	50%	50 - 100%	1
Activate buffer tank	Off	Off – On	

See operating instructions Part 1 Dosing system, regarding the respective dosing device.

## 9.6 Spare parts list, wear parts list, consumables

The spare parts and wear parts listed in the following are available through your specialist supplier. Please always include the exact product designation and the device serial number with you orders. The device serial number can be found on the control casing. Wear parts are excluded from the 2-year warranty. For these we assume a warranty of 1/2 year.

### Spare parts

<u>Device part</u>	<u>Designation</u>	<u>Item no.</u>
<b>Electrodes</b>	pH electrode cable with screw plug head (black) 2S	12006
	pH electrode cable GR	16123
	Reference-return electrode cable with screw plug head (blue) 2S	12317
	Reference-return electrode cable with screw plug head (blue) GR	18436
	Chlorine electrode ¾" complete	11980
	Chlorine electrode insert gold 19 mm	17957
	Redox electrode ½" complete	11984
	Redox electrode insert platinum 14 mm	11986
	Spray nozzle for distilled water	10406
<b>Flow-through fitting</b>	Measuring cell CPR-Touch	24271
	Maintenance set flow regulator	24716
	Ball valve PVC ¼" – 6x1 mm	12023
	Ball valve PVC ¼" – sample water extraction	11017
	Flow switch	10490
	Switch body d11 CPRT	24757
	Temperature sensor	24681
<b>Control</b>	Power supply unit CPR-Touch XL (NT_GRD_7_V3)	22328-1
	I/O- Board CPR-Touch XL (IO-GRD_7_V2)	22328
	Measuring amplifier (MV_CPRT_PR_CI)	24736
	Control panel Touch 7" (DSP_S4)	22747

### Wear parts

<u>Device part</u>	<u>Designation</u>	<u>Item no.</u>
<b>Electrodes</b>	pH electrode PG13,5 60 mm (black plug head)	10933
	Combination reference-return electrode PG13.5 (blue plug head)	18432
	Gasket set for chlorine electrode ¾"	11982
	Gasket set for redox electrode ½"	11985
	Cleaning beads 5 ml	11964
	Electrolyte 5 ml for overwintering	15945
	Buffer solution pH4 50 ml	10383
	Buffer solution pH7 50 ml	10384
	Redox test solution +468 mV 50 ml	10385
	Electrode cleaner - diaphragm cleaner 50 ml	11962
	Electrode rinsing liquid 500 ml	11963

### Consumables

Please comply with the chemicals manufacturer's safety data sheets!

**10 Appendices**

**Personal notes**

You can use the following lines for personal notes, e.g., regarding conducted service tasks or special versions, extensions or device modifications.

---

---

---

---

---

---

---

---

---

---

---

---

---

---

---

---