

# PELICAN POOL & SPA HOIST



## Freedom to be active and enjoy the water!

Designed and manufactured in Australia by Para Mobility, and tested in accordance with ASA 3581, the Pelican Pool & Spa Access Hoist allows a person with any disability to have access to both above and below ground spas, swimming & Hydrotherapy pools - without any manual lifting. It is suitable for use in public pools, leisure centres, private homes, nursing homes and schools. The unit can be mobile or fixed permanently at the edge of the pool or spa and is easily installed on the pool deck by a handyperson / tradesperson, or alternatively we can arrange installation for you. At Para Mobility, we understand that all pools are different, so we will work with you to ensure the Pelican Pool and Spa Hoist is made to meet your pool needs.

Complies with Disability Discrimination Act (Access to Premises – Buildings) under the Building Code of Australia.



# PELICAN POOL & SPA HOIST PRODUCT SNAPSHOT

## FEATURES

- Easily wheeled from one area to another for multiple use and or storage (mobile unit)
- No manual lifting required
- Press button hand switch operation
- Standard lifting capacity 150kgs and 200kg
- Cover included
- Easily installed

## SPECIFICATIONS

- **Safe Working Load:** 150kg and 200kg
- **Batteries:** Linak – 24v re-chargeable battery
- **Rotation:** Manual – 360 degrees. Power rotation available.
- **Total Weight:** From 60kg
- **Floor Mounting Plate:** 450 diameter
- **Construction:** Stainless Steel, powder coated to colour of choice
- **Hand control:** Linak - push button
- **Installation:** Anchored to pool deck with Stainless Steel anchors and eye bolts

## OPTIONAL EXTRAS

- Power rotation – push button operation

## SEATING OPTIONS

- Floating sling made by Para Mobility
- Solid plastic seat for clients with low level disabilities
- Pelican Wheelchair – designed and manufactured by Para Mobility, a great option as it can be used around the pool area
- Spinal board
- Platform lift

Proudly distributed by



(02) 9774 5550 sales@interquad.com.au interquad.com.au



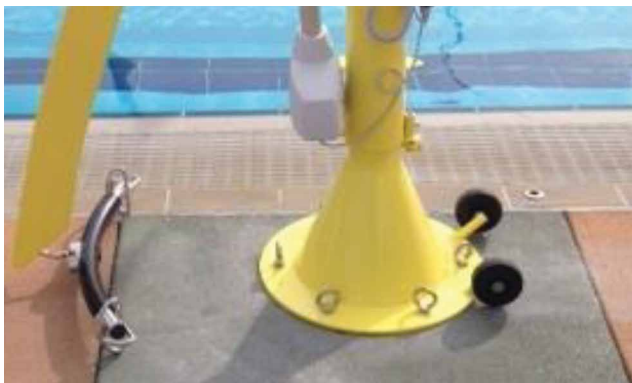

### CONCRETE PAD REQUIREMENT

IMPORTANT: To safely install the Pelican Pool Hoist you will need a solid concrete pad to anchor it to.

### CONCRETE PAD INSTALLATION

We recommend that approximately 1/3 of cubic metres of concrete is used when pouring your pad. This can be made up as a logical size, for example: 1000 x 1000 x 300 or 650 x 650 x 650. The ideal location is placed up against the pool edge.

### ANCHORING YOUR UNIT TO THE CONCRETE PAD

We provide 100mm anchors as standard which have the receiver for the eye bolts. This will secure the 450mm Pelican Pool Hoist base.

It's highly recommended to use a minimum of 20MPa concrete strength.

1. Choose the pool/deck detail that is similar to your pool and measure where applicable.

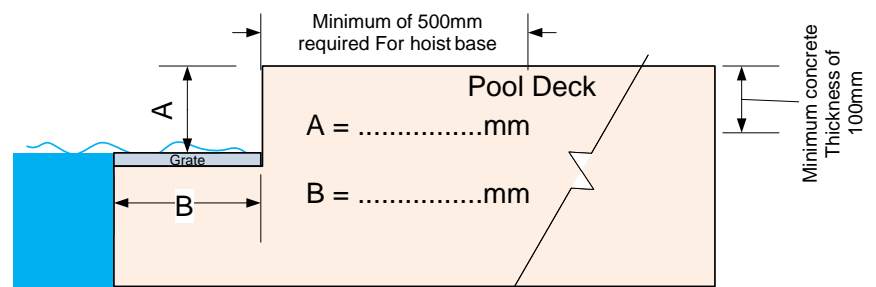
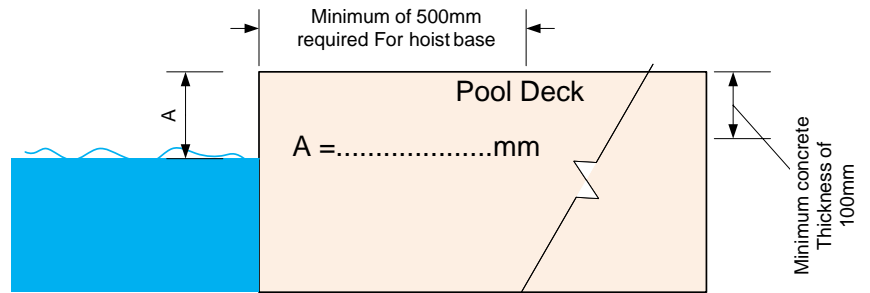
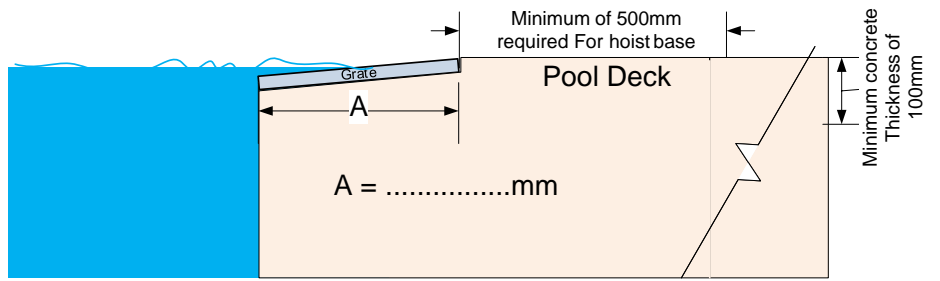

2. DO YOU HAVE THE MINIMUM CONCRETE WIDTH AND THICKNESS TO MOUNT THE HOIST ON POOL DECK  
 YES..... or NO.....

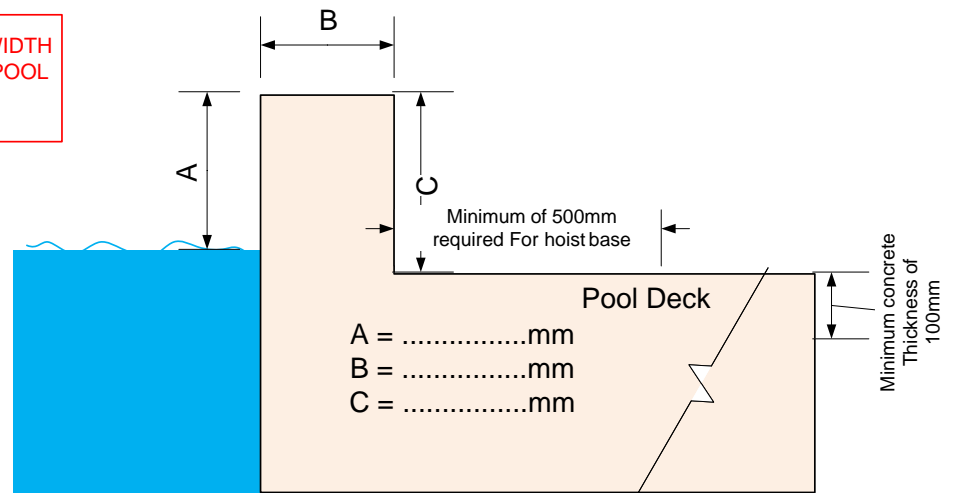

PARAMOBILITY-Pooldeckmeasuringguide		
Pelican	January 2019	CS

Customer Name.....

Pool Name.....

**Pool Hoist Colour**     Pearl White  
                                    French Blue Gloss  
                                    Other (specify).....

Contact Name..... Ph.....

The Dulux logo is presented in a bold, italicized, white sans-serif font within a dark blue rectangular box. A thin red horizontal line is positioned directly below the box.

**Dulux**<sup>®</sup>

POWDER & INDUSTRIAL COATINGS



# COLOUR SELECTOR

**Worth doing, worth Dulux.<sup>®</sup>**



POWDER & INDUSTRIAL COATINGS

10 YEAR QUALITY WARRANTY PRECIOUS POWDERCOAT RANGE

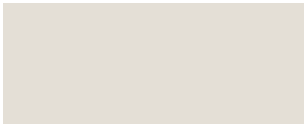

Mother of Pearl 971-84678 Gloss



Citi Pearl 971-88471 Matt



Metropolis Silver Glow Pearl 971-84623 Gloss



Nickel Pearl 971-88360 Matt



Natural Pearl 971-89119 Matt



Pandemonium Silver Pearl 971-7004F Flat



Sharp Silver Kinetic Pearl 971-7238K Satin



Copper Kinetic Pearl 971-7183K Satin



Essential Silver Pearl 260-3146Q Matt



Silver Kinetic Pearl 971-7043K Satin



St Elmos Fire Kintetic Pearl 971-7208K Satin



Champagne Kinetic Pearl 971-3059K Matt



Platypus Kinetic Pearl 971-7214K Satin



Pewter Pearl 971-88202 Satin



Typhoon Pearl 260-7469Q Satin



Gold Pearl 971-96604 Satin



Gunmetal Kinetic Pearl 971-8115K Satin



Blue Light Pearl 971-5209Q Satin



Onyx Pearl 971-52052 Gloss



Bronze Pearl 971-94686 Satin



Metropolis Bronze Pearl 971-59003 Satin



Steel Pearl 971-57127 Satin



Charcoal Met Pearl 971-18796 Gloss



Red Emperor Pearl 971-4205Q Satin

10 YEAR QUALITY WARRANTY DURALLOY POWDERCOAT RANGE



Barrister White 272-84672 Satin

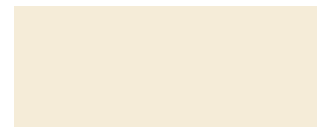

White Birch 272-37131 Gloss

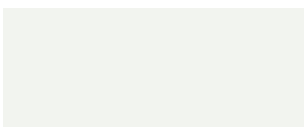

White 272-1139S Satin



Shoji White 272-84682 Satin



Anotec Off White 260-2181M Matt

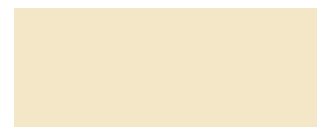

Canola Cream 272-81796 Gloss



Off White 272-33732 Satin



Magnolia 272-32658 Gloss



Paperbark 272-3088S Satin 2603174M Matt



Classic Cream 272-2095S Satin 26084732 Matt

# COLOUR SELECTOR

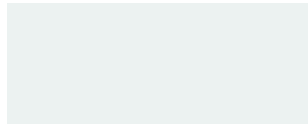

**Pearl White**

272-1114G

Gloss

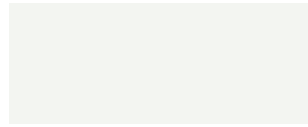

**Classic White**

272-81880

Gloss

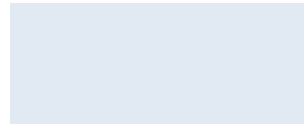

**Bright White**

272-84636

Gloss



**Grey Nurse**

260-50060

Gloss



**Oyster**

272-36858

Matt



**Surfmist®**

272-1137S Satin

2603167M Matt



**Anotec® Silver Grey**

272-51272

Matt



**Evening Haze®**

272-3055S Satin

2603168M Matt



**APO Grey**

272-32786

Satin



**Dune®**

272-3087S Satin

2607558M Matt



**Shale Grey®**

272-83246 Satin

2607557M Matt



**Cove®**

260-6250S Satin

2606252M Matt



**Windspray®**

272-7256S Satin

2607559M Matt



**Stone Grey**

272-78126

Satin



**Wedgewood**

272-50279

Satin



**Pale Eucalypt®**

260-6127S Satin

2606303M Matt



**Olde Pewter**

272-50243

Satin



**Wallaby®**

260-7474S Satin

2607476M Matt



**Blue Ridge®**

272-88480

Satin



**Wilderness®**

272-84224

Satin



**Notre Dame**

272-36672

Gloss



**Basalt®**

260-7473S Satin

2607475M Matt



**Deep Ocean®**

272-5125S Satin

2605267M Matt



**Mangrove®**

260-6262S Satin

2606251M Matt

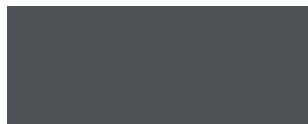

**Berry Grey**

260-88362

Satin



**Berry Grey**

272-7262G

Gloss



**Anotec® Dark Grey**

272-51275

Matt



**Cottage Green®**

272-84219 Satin

2606304M Matt



**Ironstone®**

272-7257S Satin

2607556M Matt

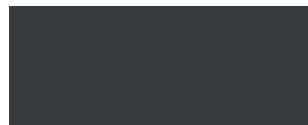

**Charcoal**

272-9086G

Gloss



**Charcoal**

272-88351

Satin



**Classic Hawthorn Green**

272-33709

Gloss



**Black (C/B Night Sky)**

272-19319

Matt

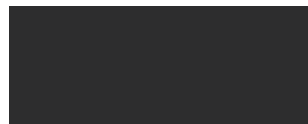

**Black (C/B Night Sky)**

272-19268

Satin



**Black**

272-9090G

Gloss



**Deep Brunswick Green**

272-6134G

Gloss

# Phone Dulux Customer service 132 499



**Light Grey**  
272-7263G Gloss



**Rivergum Beige**  
272-36991 Gloss



**Barley**  
272-3089G Gloss



**Primrose**  
272-84365 Gloss



**Gully®**  
260-8233S Satin 2608235M Matt



**Riversand®**  
959-36656 Matt



**Stone Beige**  
260-32538 Matt



**Doeskin**  
260-32516 Satin



**Woodland Grey®**  
272-7255S Satin 2606256M Matt



**Jasper®**  
272-8122S Satin 2608252M Matt



**Hammersley Brown**  
260-84657 Satin



**Terrain®**  
260-8232S Satin 2608234M Matt



**Monument®**  
2729067S Satin 2609066M Matt



**Weathered Copper**  
272-33724 Matt



**Anotec® Mid Bronze**  
272-51014 Matt



**Manor Red®**  
272-4134S Satin 2604292M Matt

• Colour to complement Colorband® Steel



**Lemon Yellow**  
984-32120 Gloss



**Safety Yellow**  
984-2015G Gloss



**Blaze Blue**  
984-19941 Gloss



**Bright Silver Metallic (with Clear Top Coat)**  
961-51491



**Yellow Gold**  
984-33617 Gloss



**Orange X15**  
984-51439 Gloss



**French Blue**  
984-32725 Gloss



**Transformer Grey**  
984-32186 Gloss



**Copper Pearl**  
961-4137Q Satin



**Signal Red**  
984-50735 Gloss



**Pommel Blue**  
984-51034 Gloss



**Mistletoe**  
984-51040 Gloss



**Anodic Bronze**  
961-19930 Satin



**Flame Red**  
984-19959 Gloss



**Space Blue**  
984-19990 Gloss



**Dark Violet**  
984-51926 Gloss



# PELICAN POOL & SPA HOIST INSTALLATION GUIDE



  
**Para Mobility**  
*Making everyday living easier since 1983*



## INSTALLATION INSTRUCTIONS PELICAN POOL HOIST

**Earthing:** As per AS3000 of the wiring rules standards – “In certain circumstances” it may be necessary to have all conductive metal objects equally potentially bonded (earthed), this includes Pool Hoists.

**We recommend you seek the advice and opinion of a qualified electrician.**

## TOOLS REQUIRED

- Hammer Drill
- 16mm masonry bit
- Hole Cleaning Pump
- Hole Cleaning Brush
- Cartridge gun – for adhesive
- Adhesive (included)
- Acetone

1. To safely install the Pelican Pool Hoist you will need a solid concrete pad to anchor it to. We recommend that approximately 1/3 of cubic metres of concrete is used when pouring your pad. This can be made up as a logical size, for example: 1000 x 1000 x 300 or 650 x 650 x 650. The ideal location is placed up against the pool edge. It's highly recommended to use a minimum of 20MPa concrete strength.
2. **Place hoist in position, ideally around 100 to 500mm from edge of pool** (can be further but check that lifting arm will reach into pool far enough to lower person into water). Check for obstructions when arm of hoist is rotated. Use the hoist base as a template.
3. **NB Anchors must be set into the concrete NOT into the tile bed or pavers. If there are pavers surrounding the pool a concrete pad must be laid** – contact Para Mobility for instructions.

4. **Drill 16mm diameter hole to a minimum of 100mm into concrete substrate.** (Example: 100mm **below** any tile bed).
5. **Remove dust and debris** by brushing and blowing 3 times each (If hole is wet or flooded, remove water with wet/dry vacuum). Hole may be damp but must not be flooded.
6. **Prepare all holes and socket studs** before continuing onto next step.
7. **Screw mixing nozzle onto Adhesive cartridge** (supplied) and dispense 2-3 trigger pulls of adhesive to waste until colour is grey with no streaks.
8. **Insert tip of nozzle** to bottom of hole and dispense adhesive.
9. **Fill hole** to about 2/3 full.
10. **Insert threaded stud socket**, with M12 threaded socket on top, with a rotating motion to release trapped air. Finish the top of the M12 threaded socket flush with finished floor, making sure that there is no adhesive in the threaded socket.
11. **Wait until adhesive has fully cured before loading.**
12. **Clean up** with acetone.



**DRILL  
HOLE**

**BRUSH  
& BLOW**

**INJECT ABRASIVE  
& INSERT STUD**

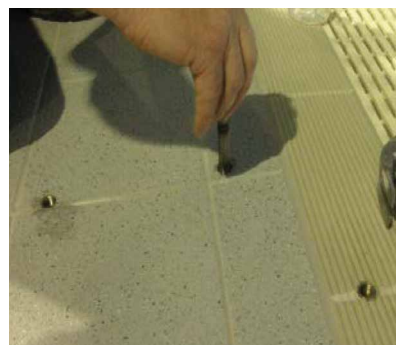
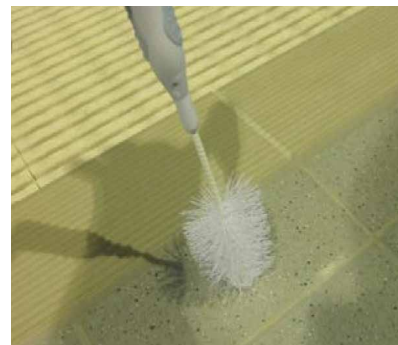
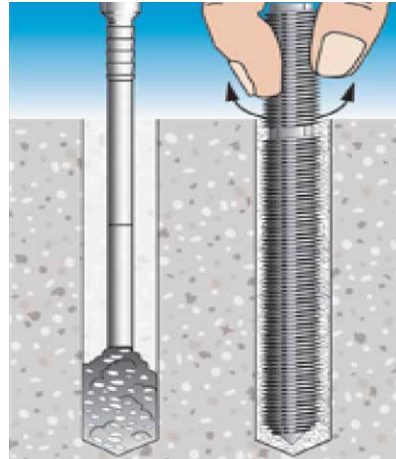
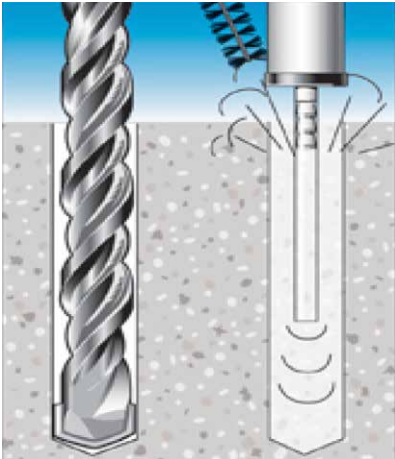

NB. Tiles can be core drilled (16mm) for a cleaner / neater finish.

## User Instructions – Pelican Wheelchair

### Entering the water

1. Place the client into the Pelican Wheelchair in the change room or desired location and wheel the chair to the pool hoist.
2. Unlock the lifter travel pin on the pool hoist.
3. Using the hand control, raise the hoist to above the client's head and wheel the chair under the lifting hanger.
4. Attach the chair straps to the lifting hanger.
5. Using the hand control slowly raise the chair off the pool deck and gently swing it over the water for lowering. A carer should be in the pool to accept the person if required.
6. The client floats or walks off the chair.
7. Send the chair back to the pool deck if required.



### Alighting from the water

1. Lower the chair to its maximum distance to allow easy access to the chair in the water
2. When the client is seated correctly, raise the chair to slightly above the pool deck and pull the arm into the safe landing area and lower just enough to land the chair for alighting, then disconnect the straps. Wheel the chair to the change room.
3. When finished, lower the arm on the pool hoist to its lowest position and install the travel pin to lock the movement. Remove the battery to the charger.



## **User Instructions – Pelican Floating Sling**

### **Entering the pool**

1. Using the hand control, raise the Pelican lifter to well above the clients head, wheel the chair under the lifting hanger
2. Slide the sling down behind the back of the client (the grab handle should be at the top, facing you) and tuck the bottom of the sling as low as possible underneath the buttock area. (figure 1)
3. Bring the legs of the sling from the outside of the thigh underneath and up between the legs ensuring you tuck the sling leg as high as possible underneath the thigh. Repeat the procedure on the other leg (figure 2)
4. Hook up the leg loops of the sling to the lifting hanger right to left, left to right.
5. Hook up the shoulder loops right to right, left to left. There should now be a total of four loops connected to the lifting hanger
6. Using the hand control, slowly raise the client off their chair and gently rotate the client over the water for lowering. A carer should be in the pool to accept the client if required.
7. Once the client is in the water, release the legs by unhooking the leg sections of the sling from the lifting hanger.
8. The client floats in the sling or floats away with the carer.

### **Exiting from the pool**

1. Lower the sling to its maximum distance to allow easy access to the sling in the water
2. When the client is seated and the straps are connected correctly, raise the sling using the hand control above the pool deck and pull the arm of the lifter into the safe landing area and lower the client onto their chair for exiting
3. When finished, lower the arm to its lowest position and install the travel pin to lock any movement.
4. Remove the battery and replace into charger.

## WARNING

- Ensure that there are no obstacles in the path of the client being lifted.
- Check that arms and legs are clear of obstructions. Failure to do so may cause injury

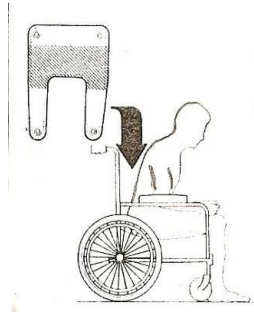

Figure 1

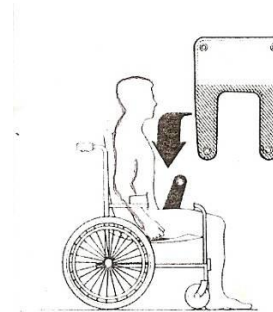
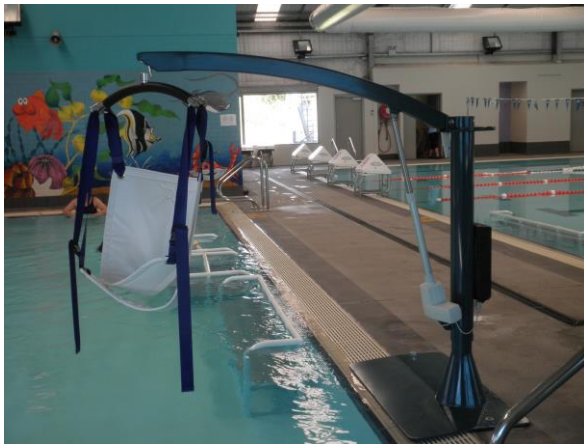
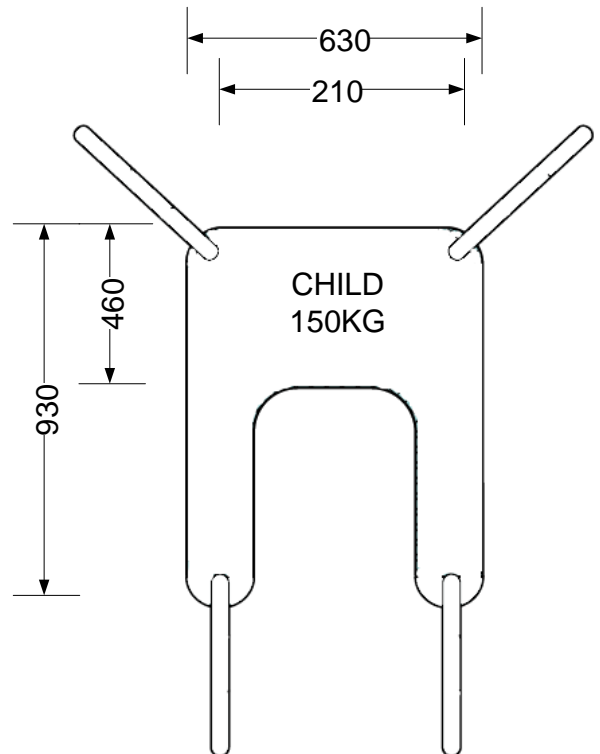
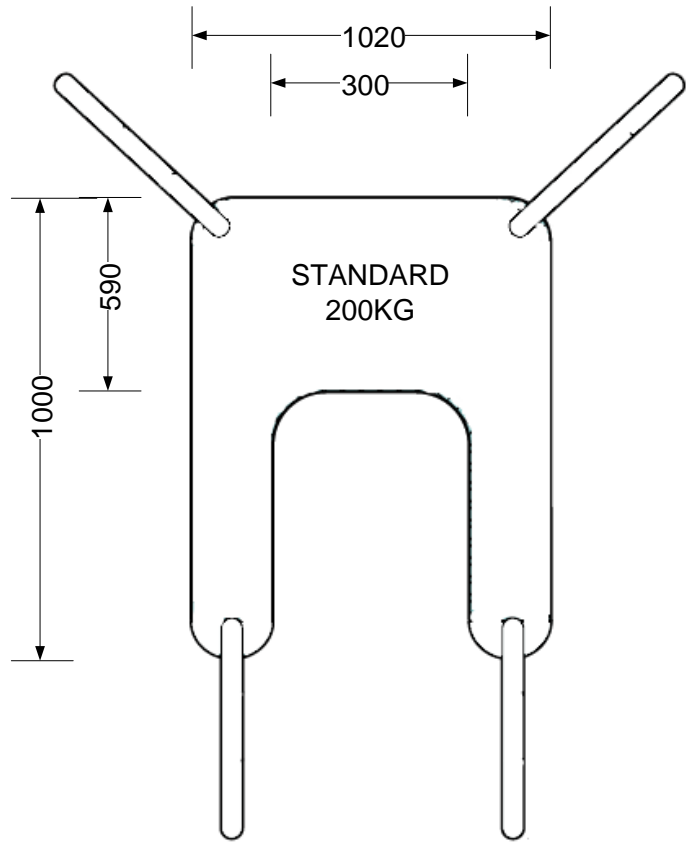
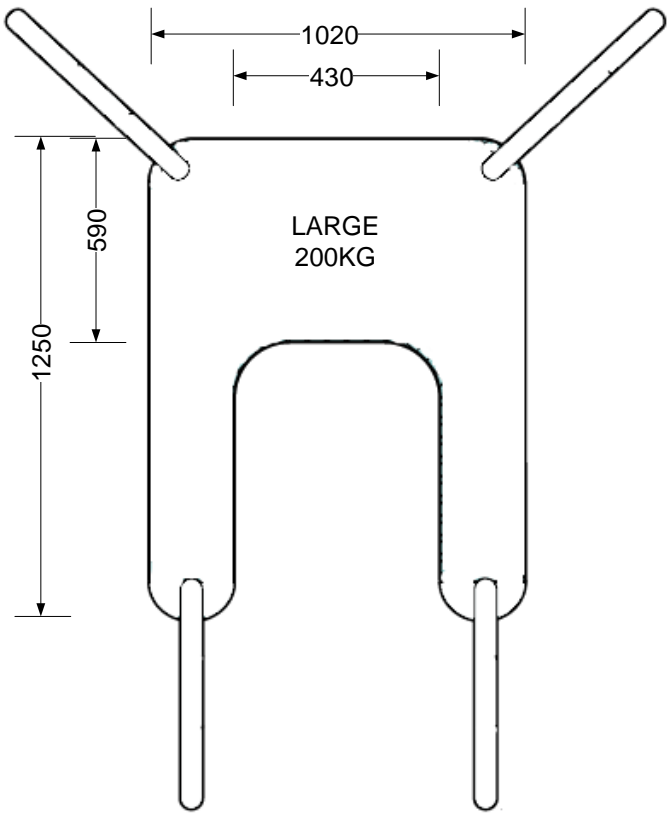

Figure 2



<p align="center"><b>PARA MOBILITY – PELICAN POOL HOIST</b></p>		
<p align="center">Floating Sling 200Kg</p>	<p align="center">CS</p>	<p align="center">April 2019</p>



## User Instructions – Pelican Pool and Spa Hoist

- **Install the Battery** – N.B Battery should always be removed and replaced into the charger after use. Do not remove the hand control from the lifter as this will disrupt the control box mechanisms.
- **Ensure the Emergency STOP button is in the out position.** If this is pushed in the hoist will not operate.

### Installation at Pool Deck (Mobile Version)

- Ensure the locking pin is engaged before transporting to stop unit from swivelling.
- Wheel the unit to the pool deck and place the base plate over the anchor points. Ensure the wheels of the hoist are placed facing away from the pool.
- Insert the Eye Bolts into the holes and **hand tighten only**.
- Unlock the locking pin.

### Use of the Lifter

- Always test the lifter by pressing up and down on the hand control before commencing a lift.
- Check safe working load (SWL) of lifter before attempting a lift and make sure the weight of person being lifted complies.
- Using the hand control, raise the lifting arm above the clients head and wheel the chair under the lifting arm, if using a sling refer to sling instructions.
- Gently swing the arm over the water and lower the hoist until the user is safely in the water.

### After use care

- Engage the locking pin to prevent the unit from swivelling.
- Wash the Pelican with clean water (not chlorinated).
- Lower arm to the lowest position and put on the cover.
- Remove the Eye Bolts from the base plate and place them in the travel holes.
- Stand behind the wheels and hold the handle, pull the unit back until travel balance is achieved.
- With care, wheel the unit to the storage area or another location.

### Battery Care

- After use, the battery should be placed in the charger to ensure it is fully charged when required. Battery cover should remain on the battery housing to avoid damage and corrosion.

### Emergency Lowering or Lifting – (Hand control override)

- If hand control is damaged – using a pen tip (or similar), push in the holes as indicated on the control box as shown. Refer to the Battery Care information page.

### Additional Emergency MANUAL Lowering

- In the case of emergency and above doesn't work, use the manual lowering as shown over the page, following the arrows on the actuator.







Manual **Emergency** Lowering



Locking Pin



Emergency **STOP** button



**Ensure eye bolts are in place** before using (if mobile version)



**Actuator – Never** push on actuator to rotate the Lifting arm. This will damage lifting mechanism

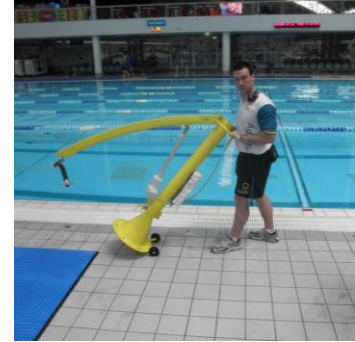

Ensure locking pin is in place before transporting (Mobile Version)

## POWER ROTATION MODEL

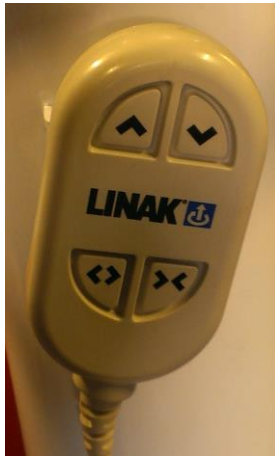

The hand control allows the Pelican Pool Hoist to go up and down and side to side.

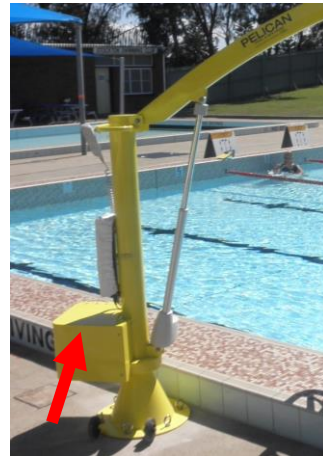

Never stand or sit on the power rotation motor

## Pelican Pool and Spa Hoist Maintenance Schedule and Service Guidelines

The Pelican Pool and Spa Hoist has been manufactured in Australia and built to Australian Standards. It is important to regularly check over your pool hoist and associated products from Para Mobility on a regular basis.

The Pelican Pool and Spa Hoist is manufactured from stainless steel. Stainless steel is a corrosion resistant alloy; however, it may display rusting characteristics under certain conditions such as in plant rooms or if the hoist is used in an indoor environment.

Following are some guidelines to assist you in developing a maintenance schedule for your hoist.

- Routinely wipe down all surfaces of the hoist, using un-chlorinated water. This will minimise the potential build-up of corrosion or rust like symptoms (*or other term is Tea Staining*).
- In the event the equipment displays stubborn stains or heavy deposit build up, specialised cleaning materials are needed to remove foreign substances to restore the original finish.
- Always use the supplied cover when not in use.
- If you have a Sling or Aquatic Wheelchair, regularly check the straps and stitching are not frayed or damaged. Ensure the SWL sticker remains on the chair. Check for any damage to the fabric or the frame of the chair.

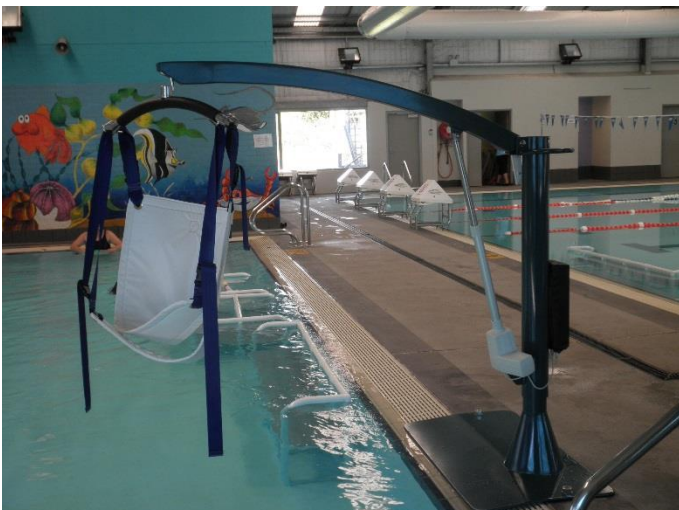

### 1. Hand Control

The Hand control is a floating hand control. **Never** take the hand control out of the control box at the bottom of the hoist unless instructed by Para Mobility or your distributor. Check the hand control by regularly pressing the button in the up and down motion and before a lift to ensure it is working correctly. Dropping the hand control on the ground, could damage the internal workings, please take care at all times.

### 2. Battery and Control Box

Pool environments can be harsh, and your battery and control box needs to be protected from the elements and chlorine products. Ensure the cover remains on the control box and battery unless changing the battery. Check that the battery and control box terminals have a small dab of light grease to ensure contact is being made. A regular check of these terminals is important to ensure every lift is successful. If any corrosion builds up on the terminals a light rub with a stainless steel pad will remove it easily.

### 3. Actuator

The actuator lifts the main arm of the hoist. The hoist must never be rotated by pushing on the actuator, this will damage the lifting mechanisms. Check to ensure it remains plugged into the bottom of the control box. It must never be removed from the control box unless instructed by Para Mobility or your distributor. When storing you pool hoist, **DO NOT** store it in a plant room where the hoist is exposed to harsh chemicals, these chemicals could damage some of the inner working of the hoist. The arm of the hoist must be kept down when not in use to minimise chemical build up on the actuator.

### 4. Safe Working Load sticker

This sticker must remain on the hoist at all times. This is the weight the hoist has been tested to lift. If this needs replacing contact Para Mobility or your distributor.

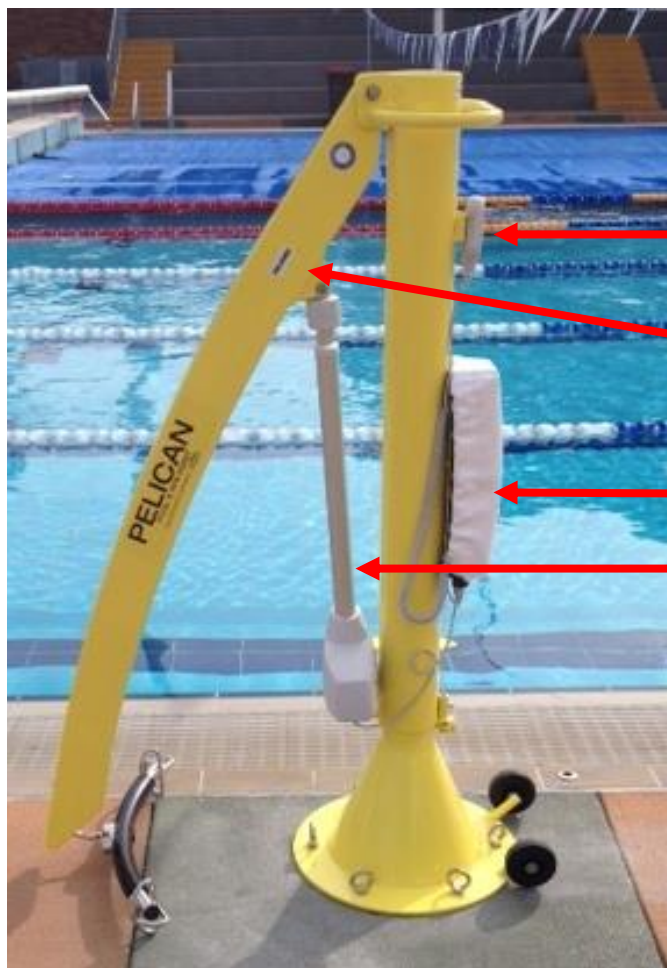

1. Floating Hand Control

4. Safe Working Load

2. Battery

3. Actuator

## Pelican Pool Cover Instructions



1. Ensure locking pin is in



2. Lower arm until lifting hanger just touches the ground



3. Twist lifting hanger whilst lowering arm



4. Pull cover over lifting hanger



5. Pull cover over wheels



## Power Rotation Cover Instructions



Ensure Hoist is down before attempting to put the cover on



Start with putting the cover over the back section first, clipping it **over the wheels** first to keep it secure.



Feed the cover over the hoist pulling it over the seat to keep it secure.

## Battery Care

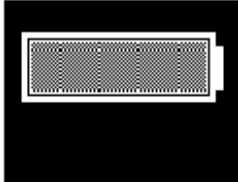

The battery is ok, no need for charging.

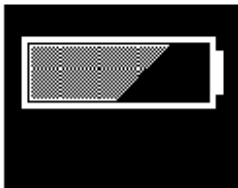

Battery needs charging.

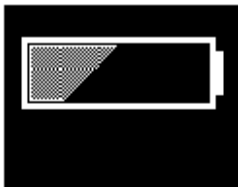

Battery needs charging. Buzzer sound is provided when a button is pressed at this battery stage.

## How to use the lowering/lifting function on the control box

### (Emergency USE)

- On the control box there are either buttons or holes.
- The lifting arm can be lowered or lifted via pressing a pen (or similar) in the hole.
- This is a permitted method of lowering/ lifting.
- The lowering/lifting “buttons” works as normal hand control buttons (you do not get extended functionality by using these when the battery is low).

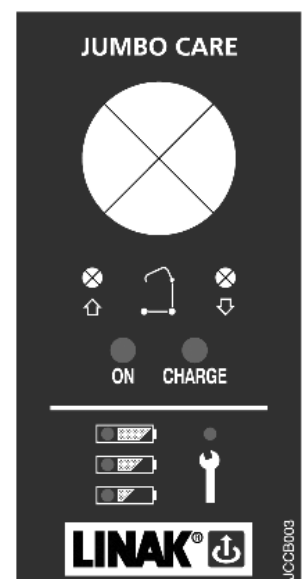

## Before moving hoist to pool deck – *Mobile Version*

Install the battery

On receipt of your hoist the battery will be charged and ready to go.

1. When not using the hoist, the battery should be removed from the hoist and placed onto the charger.
2. **NEVER** remove the hand control or the control box from the hoist.
3. **ALWAYS** leave the battery cover on the control box when not in use.
4. **ENSURE** the emergency **STOP** button is in the out position. If it is pushed in the hoist will not operate.

## Installation at Pool Deck – *Mobile Version*

1. Wheel the hoist to the pool deck and place the base plate of the hoist over the anchor points which have been inserted into the pool deck.
2. Insert the Eye Bolts into the holes and **hand tighten only**

## Operating the Pool Hoist

1. **Always** test the operation of the hoist by using the hand control, test the up and down and side to side operation before commencing a lift with a client.
2. Lift the arm rest of the seat in a horizontal motion. Once the client has transferred onto the seat commence the lift.
3. Using the hand control, raise the lifting arm high enough for the client's feet to be off the ground.
4. Using the hand control, manoeuvre the chair over the water, to the landing zone and lower.
5. **NEVER** push the hoist via the actuator to swing over the pool/spa, this will **damage** the hoist.

## Battery Care

1. A battery charger is supplied and should be placed on a wall near a 240v powerpoint in a weather / vandal proof area.
2. After use, the battery should be placed on the charger to ensure it is fully charged when required next.

## Safety and Care

There is an emergency lowering / up buttons located on the front of the control box should the need ever arise. E.g Hand control damaged.

1. Emergency lowering – push in buttons are just below emergency stop button  
– **see Battery Care sheet**

## Trouble Shooting

Hoist won't work?

- Check the emergency red button is out
- Check the battery is charged
- Check the hand control hasn't been damaged
- Check for any corrosion on the terminals of the battery and the control box
- **Call Para Mobility or your supplier if you have any questions or concerns.**

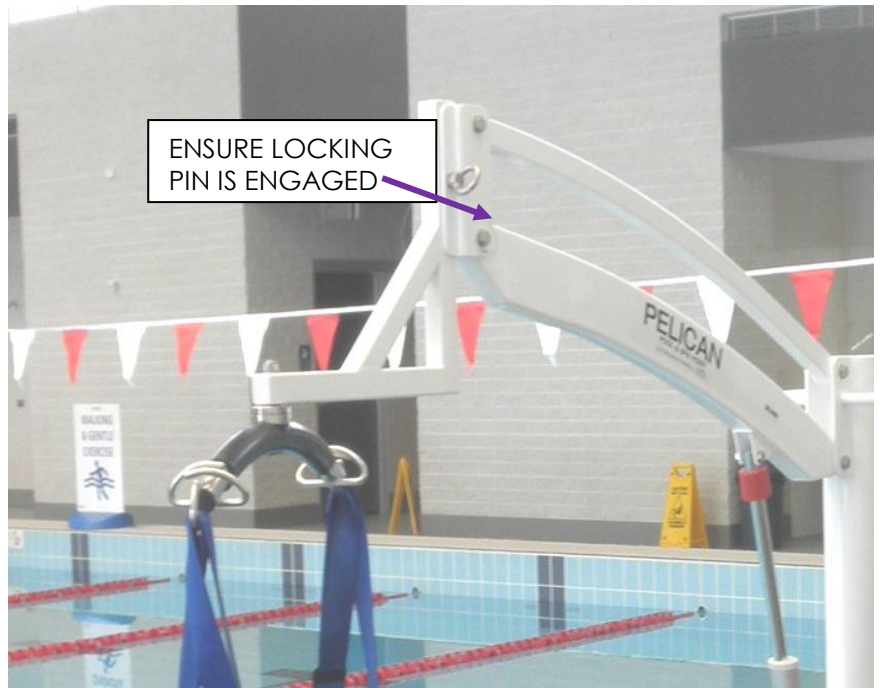

**ALWAYS:**

Ensure the locking pin is engaged to prevent the seat / lifting hanger from falling from the hoist.

Release Adaptor allowing interchange of Solid seat and sling/ aquatic wheelchair

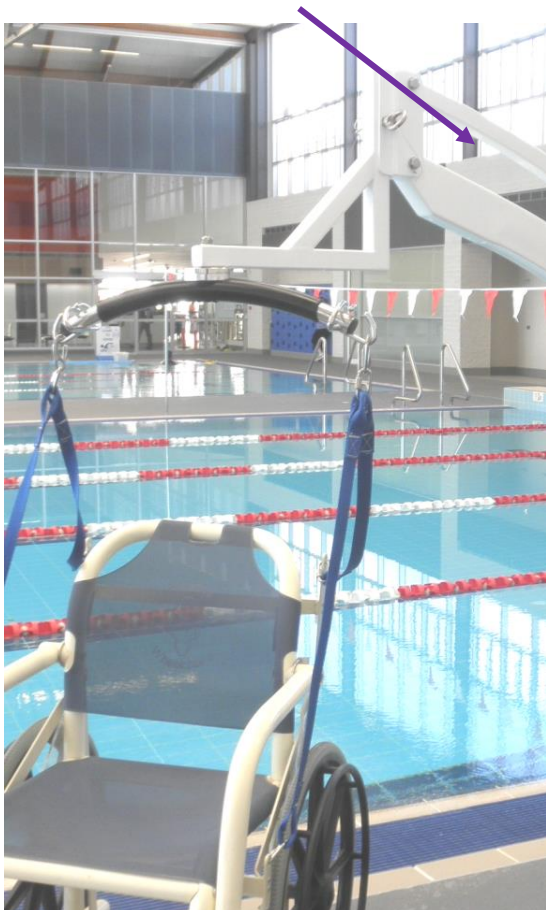





IT'S ALL ABOUT ACCESS  
& FREEDOM



Proudly distributed by



(02) 9774 5550 sales@interquad.com.au interquad.com.au

